

# ALLIED

## Étude d'impact sur les déplacements

Projet Le Nordelec, arrondissement Sud-Ouest



**CIMA+**

Numéro de projet CIMA+ : L02373H  
8 novembre 2022 – Révision 02



# Étude d'impact sur les déplacements

Projet Le Nordelec, arrondissement Sud-Ouest

Préparé par :

Eric Séguin, ing., RSP  
N° de membre O.I.Q. : 5058700

Moustapha Seck, ing., MBA  
N° de membre O.I.Q. : 145630

Relu par :

Mathieu Côté, urb., M.ATDR, ENV SP  
N° de membre OUQ. : 1274



740, rue Notre-Dame Ouest, bur. 900  
Montréal, QC H3C 1J2

Numéro de projet CIMA+ : L02373H  
8 novembre 2022 – Révision 02

## Tableau des ressources impliquées

En plus des signataires du présent rapport, les personnes suivantes ont également participé à l'étude et la rédaction du rapport en tant qu'experts techniques au sein de l'équipe de projet :

Nom	Discipline
François Viard, CPI	Modélisation, simulations
Maryse Poirier	Graphismes

Registre des révisions et émissions			
N° de révision	Révisé par	Date	Description de la modification et/ou de l'émission
01	MC	2022-11-07	Rapport complet
02	MC	2022-11-08	Rapport complet - révisé

## Propriété et confidentialité

À moins d'entente entre CIMA+ s.e.n.c. et son client à l'effet contraire, tous les documents, qu'ils soient imprimés ou électroniques, ainsi que tous les droits de propriété intellectuelle qui y sont contenus, appartiennent exclusivement à CIMA+ s.e.n.c., laquelle réserve tous ses droits d'auteur. Toute utilisation ou reproduction sous quelque forme que ce soit, même partielle, est strictement interdite à moins d'obtenir l'autorisation de CIMA+ s.e.n.c.

## Table des matières

<b>1.</b>	<b>Introduction .....</b>	<b>1</b>
1.1	Mise en contexte .....	1
1.2	Mandat et méthodologie.....	2
<b>2.</b>	<b>Caractérisation de la situation actuelle .....</b>	<b>3</b>
2.1	Portrait de la trame urbaine.....	3
2.1.1	Configuration de la trame urbaine.....	3
2.1.2	Impact de la trame urbaine sur les déplacements .....	3
2.2	Offre en réseaux de déplacements .....	4
2.2.1	Réseau routier.....	4
2.2.2	Le camionnage.....	8
2.2.3	Réseau de transport collectif.....	9
2.2.4	Réseau actif .....	10
2.3	Conditions de circulation actuelles .....	12
2.3.1	Comptages de circulation.....	12
2.3.2	Indicateur de performance .....	13
2.3.3	Résultats des simulations .....	13
<b>3.</b>	<b>Situation future.....</b>	<b>15</b>
3.1	Projet.....	15
3.2	Impacts sur les déplacements.....	16
3.2.1	Génération des déplacements .....	16
3.2.2	Distribution et affectation des déplacements .....	17
3.2.3	Conditions de circulation anticipées .....	19
3.3	Fonctionnalité du site .....	21
3.3.1	Nombre et localisation des accès .....	21
3.3.2	Dégagement de la visibilité aux accès .....	21
3.4	Le stationnement.....	22
3.4.1	Offre de stationnement proposée versus le règlement d'urbanisme.....	22
3.4.2	Demande de stationnement.....	22
<b>4.</b>	<b>Plan de gestion des déplacements .....</b>	<b>24</b>
4.1	Objectifs du plan de gestion des déplacements.....	24
4.2	Avantages du plan d'implantation .....	24
4.3	Mesures incitatives.....	25
<b>5.</b>	<b>Conclusion.....</b>	<b>28</b>

## Liste des figures

Figure 1.1 : Secteur à l'étude.....	1
Figure 2.1 : Hiérarchie routière et modes de gestion.....	5
Figure 2.2 : Réseau de camionnage.....	8
Figure 2.3 : Réseau de transport collectif.....	9
Figure 2.4 : Réseau de transport actif.....	11
Figure 2.5 : Conditions de circulation actuelles – Heure de pointe du matin.....	14
Figure 2.6 : Conditions de circulation actuelles – Heure de pointe de l'après-midi.....	14
Figure 3.1 : Localisation des îlots du projet.....	15
Figure 3.2 : Conditions de circulation anticipées – Heure de pointe du matin.....	20
Figure 3.3 : Conditions de circulation anticipées – Heure de pointe de l'après-midi.....	20
Figure 3.4 : Corridor libre d'obstacle.....	21
Figure 3.5 : Demande instantanée théorique en stationnement – Jour de semaine typique.....	23

## Liste des tableaux

Tableau 1.1 : Activités prévues au mandat.....	2
Tableau 2.1 : Caractéristiques des axes desservant le site à l'étude.....	6
Tableau 2.2 : Délais associés aux niveaux de service.....	13
Tableau 3.1 : Synthèse des usages et de l'offre en stationnement du projet.....	15
Tableau 3.2 : Débits véhiculaires générés par le projet-Heure de pointe du matin.....	17
Tableau 3.4 : Distribution des déplacements générés par le projet aux périodes de pointe.....	18
Tableau 3.5 : Offre de stationnement exigée versus celle proposée pour le projet.....	22
Tableau 4.1 : Mesures appropriées dans le cadre du plan de gestion des déplacements.....	26

## Liste des photos

Photo 2.1 : Rue Saint-Patrick, à l'ouest de Shearer.....	6
Photo 2.2 : Shearer, au sud de la rue Richardson.....	6
Photo 2.3 : Rue Richardson, à l'est de la rue Shearer.....	7
Photo 2.4 : Rue De Montmorency, au sud de la rue St-Patrick.....	7

## Liste des annexes

Annexe A Plan d'implantation du projet	
Annexe B Détail des simulations de l'actuel	
Annexe C Détail de la génération	
Annexe D Détail des simulations anticipées	
Annexe E Détail des analyses de stationnement	

# 1. Introduction

## 1.1 Mise en contexte

CIMA+ a réalisé la première étude d'impact sur les déplacements en 2005<sup>1</sup> pour le projet Le Nordelec, ainsi que plusieurs notes techniques, dont la plus récente (Volet 1) date de mars 2021<sup>2</sup>. Étant donné que le projet a évolué, il est requis de mettre à jour l'étude d'impact sur les déplacements afin d'identifier les impacts du nouveau projet d'ensemble sur les conditions de déplacements du secteur.

Pour effectuer cette mise à jour, les plus récentes données de comptages recueillies lors de la réalisation du Volet 1 du mandat en 2021 ont été utilisées (comptages de la Ville de Montréal, 2017 et 2019, ajustés par CIMA+).

Le secteur d'étude retenu aux fins d'analyse des impacts du projet est délimité par la rue Saint-Patrick au nord, la rue Centre au sud, la rue Wellington à l'est et la rue Island à l'ouest. Le site du projet, quant à lui, est délimité par les rues Saint-Patrick, Richardson, Shearer et De Montmorency, dans le secteur de Pointe-Saint-Charles.

La figure 1.1 présente le site à l'étude ainsi que la localisation des points de comptages de la Ville de Montréal, alors que l'annexe A présente le plan d'implantation du projet.

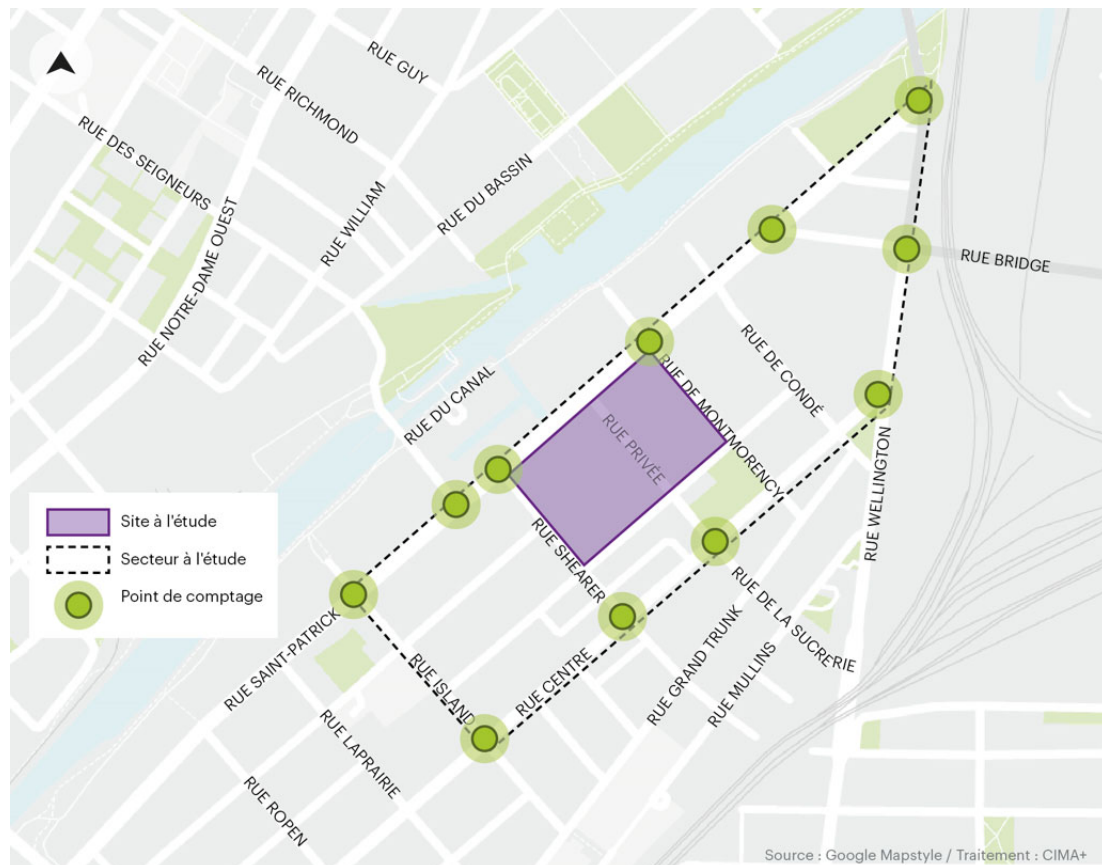

Figure 1.1 : Secteur à l'étude  
Source : Google | Traitement : CIMA+

<sup>1</sup> Étude d'impact sur les déplacements réalisée, CIMA+, 2005, N/Réf. : L02373A.

<sup>2</sup> Avis technique en circulation, étude d'impact sur les déplacements-Projet Le Nordelec, à Montréal. N/Réf. : L02373G.

## 1.2 Mandat et méthodologie

ALLIED a mandaté CIMA+ afin de mettre à jour l'étude d'impact sur les déplacements du projet Le Nordelec, dont la première a été réalisée en 2005.

Plus spécifiquement, conformément à l'offre de services professionnels, le mandat se décline en trois grands volets :

Plus spécifiquement, le mandat se décline en trois grands volets :

- + Volet 1 : Portrait de la situation actuelle;
- + Volet 2 : Analyse de la situation future;
- + Volet 3 : Plan de gestion des déplacements.

Le tableau 1.1 synthétise les activités des différents volets de la présente étude.

*Tableau 1.1 : Activités prévues au mandat*

<b>Volet 1</b> <b>Portrait de la situation actuelle</b>	<b>Volet 2</b> <b>Analyse de la situation future</b>	<b>Volet 3</b> <b>Plan de gestion des déplacements</b>
<ul style="list-style-type: none"><li>• Collecte des intrants</li><li>• Relevés terrain</li><li>• Caractérisation de l'offre en réseaux de déplacements</li><li>• Analyse de l'offre en stationnement</li><li>• Simulation des conditions de circulation actuelles</li></ul>	<ul style="list-style-type: none"><li>• Génération, distribution et affectation des déplacements générés par le projet</li><li>• Simulation des conditions de circulation anticipées</li><li>• Analyse sommaire de l'accessibilité au site</li><li>• Analyse de l'offre et de la demande en stationnement</li></ul>	<ul style="list-style-type: none"><li>• Analyse globale</li><li>• Analyse de la configuration projetée du site</li><li>• Analyse de la connectivité du site aux réseaux collectif et actif</li><li>• Formulation de recommandations, au besoin</li></ul>

## 2. Caractérisation de la situation actuelle

Ce chapitre présente un portrait de la situation actuelle en caractérisant l'offre en réseaux de déplacements et les conditions de circulation actuelles dans le secteur à l'étude.

### 2.1 Portrait de la trame urbaine

#### 2.1.1 Configuration de la trame urbaine

Le secteur d'étude est enclavé par le canal de Lachine situé au nord et par les liens ferroviaires qui le ceinturent du côté sud, lesquels constituent des barrières anthropiques qui limitent la perméabilité du secteur. Le site du projet fait partie des secteurs à vocation économique et identifié en vue de l'application de la stratégie de revitalisation urbaine intégrée, selon le plan d'urbanisme de l'arrondissement Sud-Ouest.

Malgré la présence de ses barrières anthropiques, le secteur d'étude demeure desservi par un réseau routier structurant qui est principalement constitué des rues Wellington, Bridge et Centre, alors que l'autoroute Bonaventure est l'axe majeur qui assure le raccordement du secteur au centre-ville de Montréal à l'extrémité est de l'arrondissement du Sud-Ouest, au réseau régional d'autoroutes (A-10, A-15, A-20 et A-720) et au pont Champlain. Les rues Wellington et Bridge sont sollicitées par des mouvements pendulaires lors des périodes de pointe du matin et de l'après-midi, entre le centre-ville de Montréal et la Rive-Sud via le pont Victoria. Cet ouvrage d'art précité, offrant deux voies de circulation, est utilisé de manière directionnelle pendant les périodes de pointe de la journée, c'est-à-dire en direction de Montréal le matin et vers la Rive-Sud l'après-midi. La portion est du secteur d'étude est donc habituellement traversé par des mouvements pendulaires entre le centre-ville et la Rive-Sud, via les rues Wellington et Bridge. La rue Centre est considérée comme une rue commerciale structurante et un pôle d'activité de quartier à consolider.

Les transports collectifs sont assurés par les nombreuses lignes d'autobus de la STM et la ligne verte du métro de Montréal qui se situe à l'ouest du secteur d'étude avec la présence de la station Charlevoix à ± 800 m du site du projet Le Nordelec.

Le secteur est desservi par un réseau cyclable structurant, lequel est principalement constitué des pistes cyclables bordant le canal de Lachine et permettant de joindre directement le centre-ville via les rues permettant de rallier le centre-ville via les axes McGill et Peel.

#### 2.1.2 Impact de la trame urbaine sur les déplacements

Les contraintes physiques susmentionnées, soit le canal de Lachine au nord et les voies ferrées au sud, limitent l'accessibilité du secteur d'étude pour la circulation et aussi pour les modes actifs et collectifs. Cette accessibilité limitée se traduit par la présence de seulement deux ouvrages de franchissement du canal de Lachine à proximité du secteur d'étude, soit l'axe Wellington, qui supporte habituellement des mouvements pendulaires (entre le centre-ville et la Rive-Sud) et est souvent sujet à la congestion routière récurrente, et la rue des Seigneurs.



La présence des voies ferrées rend difficile les déplacements des modes actifs, notamment des piétons vers la portion sud de Pointe-Saint-Charles, car celle-ci constitue une barrière étanche aux déplacements actifs. Cependant, la présence du REM (antenne Rive-Sud) avec une station potentielle est prévue au coin nord-ouest de Wellington / Bridge, proche du bassin Peel. Cela améliorerait significativement l'accessibilité en transport en commun et l'attractivité du secteur. Cette station ne sera toutefois pas construite en prévision de la mise en service de l'antenne au courant de l'année 2023. Toutefois, elle demeure potentiellement faisable puisque l'alignement droit minimal pour permettre l'insertion d'une station a été préservé dans le secteur (à proximité de l'intersection Bridge/Wellington).

Comme mentionné précédemment, le canal de Lachine est bordé d'un réseau cyclable structurant permettant de joindre directement le centre-ville. Ainsi, la présence de ce canal, bien que constituant en quelque sorte une barrière pour les déplacements, offre quand même un cadre de vie agréable et invitant aux usagers du secteur notamment pour les déplacements actifs. Grâce à son caractère structurant, son potentiel récréotouristique indéniable et son patrimoine industriel unique, le canal de Lachine revêt une importance stratégique majeure pour le développement urbain de Montréal. D'ailleurs, dans les orientations générales du plan d'urbanisme, la Ville de Montréal a prévu de faire des abords du canal de Lachine un lieu d'une grande qualité en intensifiant et diversifiant les activités et en renforçant son caractère d'ensemble, tout en améliorant l'accessibilité au secteur et la continuité spatiale des sites avoisinants au canal.

## 2.2 Offre en réseaux de déplacements

Cette section caractérise les différents réseaux de déplacements composant le secteur à l'étude, soit le réseau routier, le réseau de transport collectif et le réseau actif.

### 2.2.1 Réseau routier

La figure 2.1 illustre la hiérarchie routière associée au secteur à l'étude ainsi que le mode de gestion des intersections.

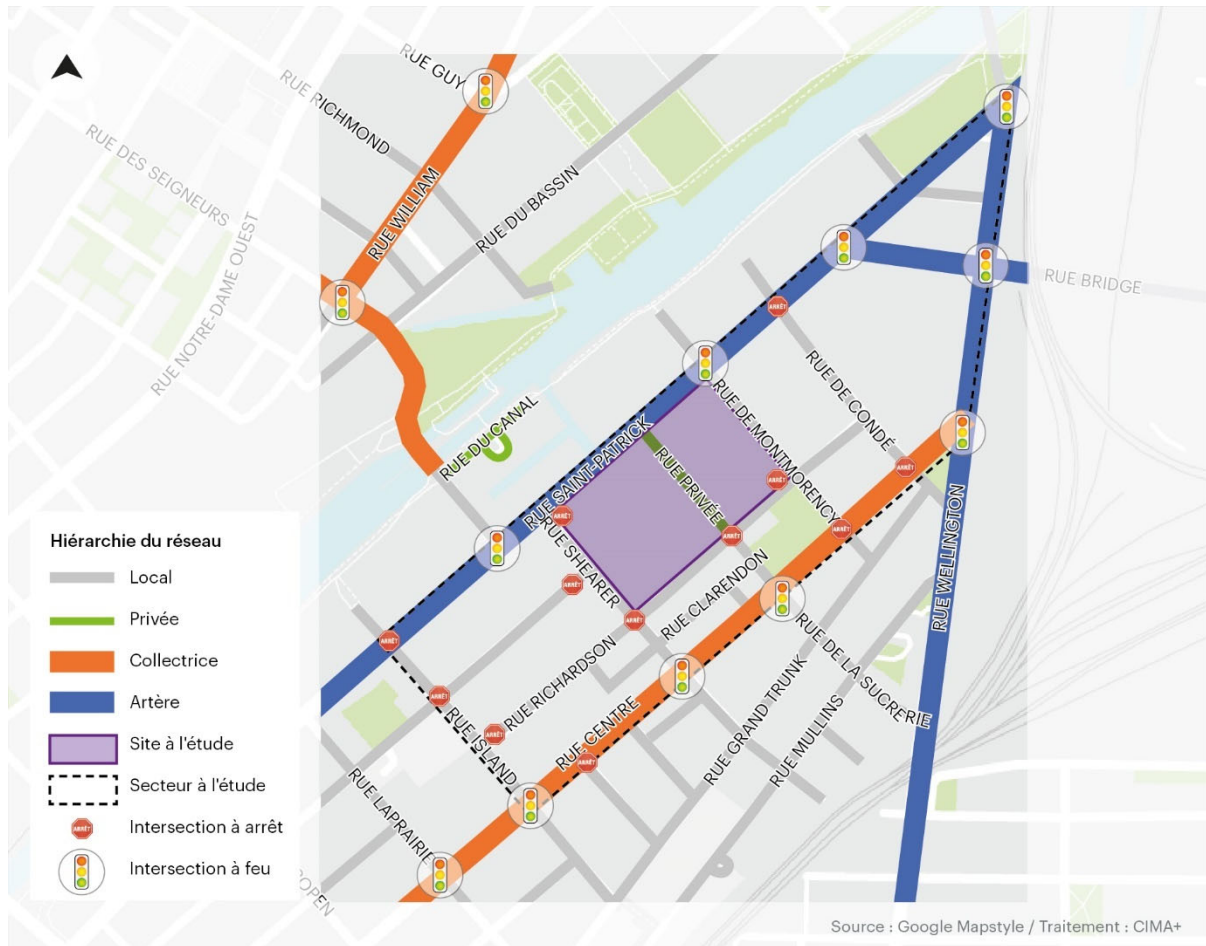

Figure 2.1 : Hiérarchie routière et modes de gestion  
Source : Google, Ville de Montréal | Traitement : CIMA+

Les rues Saint-Patrick, Wellington et Bridge jouent le rôle d'artères qui assurent une fonction prépondérante de transit et de distribution du secteur d'étude. D'ailleurs, comme mentionné précédemment, ce sont les axes Wellington et Bridge qui permettent aux usagers du secteur d'étude de rallier le réseau régional d'autoroutes (A-10, A-15, A-20 et A-720) et les ponts Champlain et Victoria. La rue Centre est une route collectrice, hiérarchie en adéquation avec son statut d'axe commercial principal du quartier.

Tous les autres axes routiers sont des routes locales, exclusivement dédiées à l'accès aux propriétés.

En complément à la figure précédente, le tableau 2.1 présente les principales caractéristiques des axes ceinturant le site du projet, soit les rues Shearer, Saint-Patrick, Richardson et de Montmorency.

Tableau 2.1 : Caractéristiques des axes desservant le site à l'étude

Caractéristique	Rue Saint-Patrick	Rue Shearer	Rue Richardson	Rue De Montmorency
Sens de l'écoulement	Est-Ouest	Nord-Sud	Est-Ouest	Nord-Sud
Configuration	1 voie/direction	1 voie/direction	1 voie/direction	1 voie/direction
Vitesse affichée	40 km/h	30 km/h	30 km/h	30 km/h
Stationnement sur rue	Permis des deux côtés	Permis des deux côtés	Permis des deux côtés	Permis des deux côtés

Les photos 2.1 à 2.4 illustrent, quant à elles, les axes susmentionnés, à proximité du site du Nordelec.



Photo 2.1 : Rue Saint-Patrick, à l'ouest de Shearer  
 Source: Google (2022)



Photo 2.2 : Shearer, au sud de la rue Richardson  
 Source: Google (2022)



*Photo 2.3 : Rue Richardson, à l'est de la rue Shearer  
Source : Google (2022)*



*Photo 2.4 : Rue De Montmorency, au sud de la rue St-Patrick  
Source : Google (2022)*

## 2.2.2 Le camionnage

Le réseau de camionnage associé au secteur à l'étude est présenté sur la carte suivante.

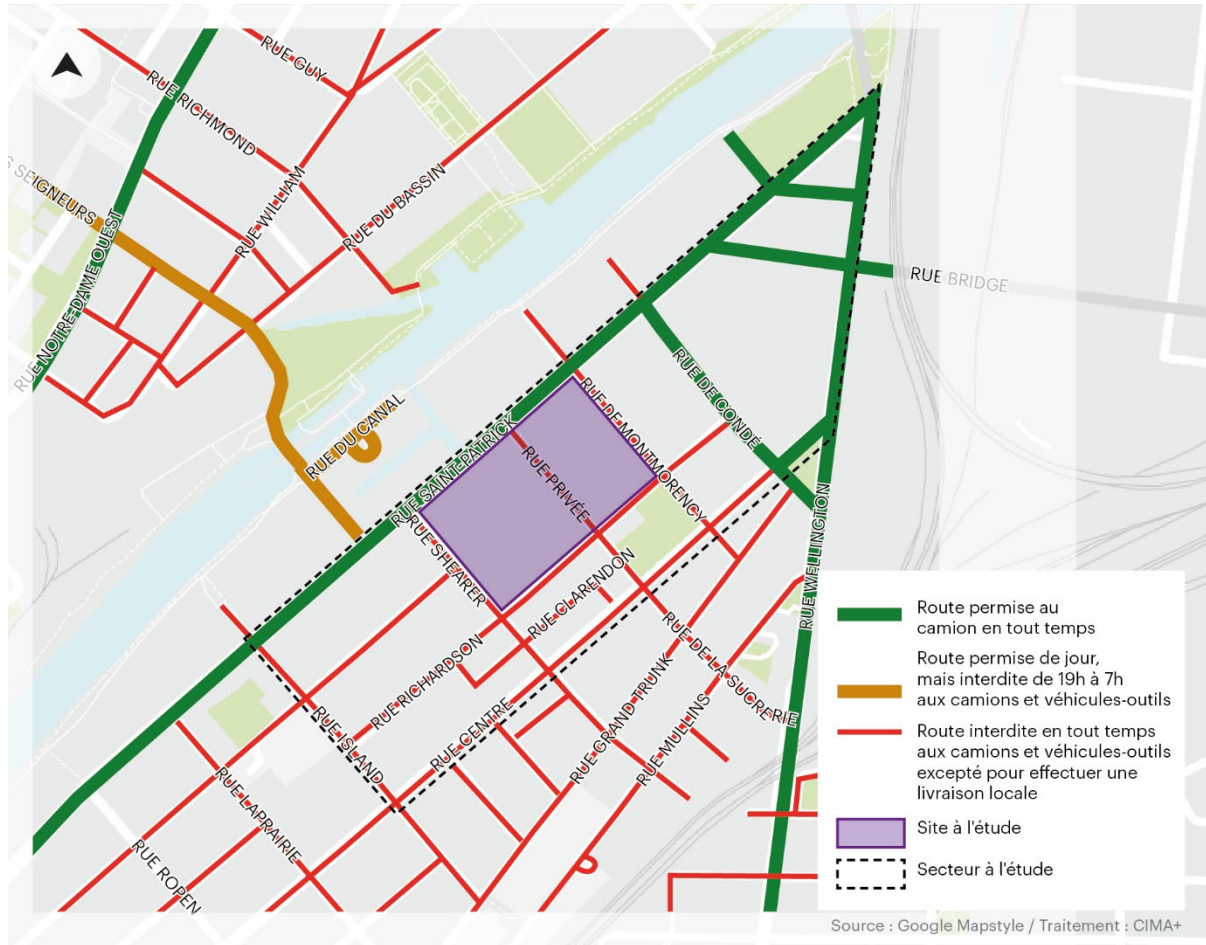

Figure 2.2 : Réseau de camionnage  
Source : Google, Ville de Montréal | Traitement : CIMA+

Il est constaté que le camionnage est seulement permis sur les axes structurants du secteur d'étude, soit les rues Bridge, Wellington et Saint-Patrick. Les rues résidentielles composant le secteur à l'étude sont interdites aux camions, à l'exception des livraisons locales.

## 2.2.3 Réseau de transport collectif

La figure 2.3 illustre le réseau de transport collectif desservant le secteur à l'étude.



Figure 2.3 : Réseau de transport collectif  
Source : Google, Ville de Montréal | Traitement : CIMA+

Le réseau de transport collectif présent à proximité du site d'étude est bien développé. Cinq lignes d'autobus de la STM traversent le secteur étudié, permettant de faire des liens avec le réseau de métro de la STM, en particulier la station Charlevoix, mais également avec le centre-ville et les quartiers adjacents, tels que Griffintown et Verdun. Les lignes présentent dans les limites du secteur d'études sont les suivantes :

- + La ligne 57 : sur la rue du Centre, elle relie les stations Charlevoix, Atwater et Guy-Concordia;
- + La ligne 61 : sur la rue Wellington, elle relie le quartier de Verdun au centre-ville;
- + La ligne 71 : présente sur le réseau local de Pointe-Saint-Charles, elle relie les stations de métro LaSalle, Charlevoix et Lionel-Groulx;
- + La ligne 74 : présente sur la portion ouest du secteur sur les rues Bridge et Wellington, elle permet un lien entre le centre-ville et la cité du Havre et les studios Mels;
- + La ligne 107 : traversant le secteur d'étude par la rue du Centre, cette ligne permet un lien entre Verdun et le centre-ville.

Le réseau de métro de la STM est principalement accessible par la station Charlevoix de la ligne verte, située sur la rue du Centre, à moins de 800 mètres du site du Nordelec (environ 10 min de marche). La station Georges-Vanier est la plus proche sur la ligne orange, à une distance de marche d'environ 1,5 km du site du projet, mais demande toutefois de traverser le canal de Lachine.

Il est également pertinent de rappeler le Réseau express métropolitain (REM), planifié par la CDPQ Infra, qui est une ligne de transport en commun lourd dotée de plusieurs antennes, soit l'antenne Rive-Sud et les antennes situées au nord (Deux-Montagnes, L'Anse-à-l'Orme et Aéroport). La station prévue la plus proche du site du Nordelec est la station Griffintown-Bernard-Landry, située à la limite entre les quartiers Griffintown et Ville-Marie, à proximité du boulevard Robert-Bourrassa. Elle est à environ deux kilomètres de marche du projet étudié (environ 1,5 km à vol d'oiseau). Une station plus proche, au Bassin Peel, avait été prévue par CDPQ Infra dans une étude produite en 2017, mais sa construction n'est pas prévue dans le cadre de la mise en service de l'antenne Rive-Sud attendue au courant de l'année 2023. Elle demeure quand même potentiellement faisable puisque l'alignement droit minimal pour permettre l'insertion d'une station a été préservé dans le secteur, à proximité de l'intersection Bridge et Wellington, soit à 750 mètres du projet du Nordelec.

Finalement, six stations Communauto sont présentes à proximité du site étudié, tel que présenté sur la carte ci-dessus.

## 2.2.4 Réseau actif

La figure 2.4 illustre le réseau de transport actif desservant le secteur à l'étude.





Des stations BIXI sont également présentes dans le secteur. On compte six bornes pour une capacité totale de 175 vélos dans le secteur étudié.

## 2.3 Conditions de circulation actuelles

### 2.3.1 Comptages de circulation

CIMA+ a utilisé les plus récentes données de comptages recueillies lors de la réalisation du volet 1 du mandat réalisé en 2021, soit les comptages de la Ville de Montréal datant de 2017 et 2019 pour intersections sises à proximité du site. CIMA+ a ensuite ajusté à la hausse les débits comptés sur le réseau routier afin de tenir compte de la situation la plus conservatrice.

Par ailleurs, afin d'obtenir une meilleure représentativité des simulations, CIMA+ a pris compte les débits des intersections Bridge/Wellington et Wellington/Saint-Patrick, soit deux carrefours stratégiques où transitent les mouvements pédiulaires observés entre la Rive-Sud et le centre-ville de Montréal.

Les heures de pointe s'établissent comme suit :

- + Heure de pointe du matin : 7 h 30 à 8 h 30;
- + Heure de pointe de l'après-midi : 16 h à 17 h.

Il est à noter que les travaux du REM, lesquels sont en cours dans le secteur d'étude, engendrent des entraves à la circulation et des chemins de détour. En fait, la direction est de la rue Saint-Patrick, entre les rues Bridge et Wellington, ainsi que la direction ouest de l'axe Wellington, entre Bridge et Saint-Patrick, sont temporairement fermées à cause des travaux. Alors, une modification temporaire des patrons de circulation est observée sur le réseau routier du secteur d'étude et celle-ci se traduit par une affectation des débits sur Saint-Patrick en direction est sur la rue Bridge en virage à droite puis sur la rue Wellington en virage à gauche. Le débit en direction ouest sur la rue Wellington, quant à lui, a été affecté sur la rue Saint-Patrick en virage à droite puis sur la rue Bridge en virage à gauche.

La Ville de Montréal a ajusté les séquences de phases et minutages aux intersections concernées par les travaux afin de tenir compte des nouveaux patrons de circulation (Bridge/Wellington, Wellington/Saint-Patrick et Saint-Patrick/Bridge).

À l'heure de pointe du matin, les débits de circulation les plus élevés sur le réseau routier sont observés sur les rues Bridge et Wellington en direction du centre-ville. En effet, à l'approche sud de Bridge/Wellington, il y a  $\pm 1\,000$  véh./h en virage à droite, et cette charge augmente graduellement pour se chiffrer à  $\pm 1\,530$  véh./h sur la rue Wellington au nord de Saint-Patrick, soit sur le pont Wellington. À l'heure de pointe de l'après-midi, un patron inverse est observé, c'est-à-dire que la charge est principalement dirigée vers la Rive-Sud via les rues Wellington et Bridge puis le pont Victoria. En effet, il y a  $\pm 1\,150$  véh./h sur le pont Wellington en direction sud et le débit augmente graduellement pour atteindre  $\pm 1\,575$  véh./h sur la rue Bridge au sud de Wellington, soit en direction du pont Victoria.

Dans le secteur avoisinant au site à l'étude, les débits sont globalement faibles, comparés aux volumes pendulaires sus-évoqués. C'est dans l'axe Saint-Patrick en direction ouest le matin où il est observé les débits les plus élevés avec  $\pm 590$  véh./h à l'approche est de Montmorency. À l'heure de pointe de l'après-midi, le volume le plus élevé sur Saint-Patrick est observé à l'approche ouest de Shearer, avec  $\pm 780$  véh./h.

### 2.3.2 Indicateur de performance

L'indicateur retenu pour les analyses de performance du réseau routier est le niveau de service. Ce dernier permet de qualifier la qualité de la circulation à une intersection ainsi qu'aux approches et mouvements de celle-ci. Le niveau de service « A » exprime une excellente fluidité du trafic tandis que le niveau de service « F » définit une mauvaise circulation (intersection saturée). Les niveaux intermédiaires entre « A » et « F » définissent des conditions variables entre ces deux extrêmes, sur la base des délais moyens par véhicule. Le tableau 2.2 présente les délais associés au niveau de service, selon le mode de gestion à l'intersection.

Tableau 2.2 : Délais associés aux niveaux de service

Niveau de service	Qualité de l'écoulement	Délais moyens par véhicule (intersection gérée par des arrêts)	Délais moyens par véhicule (intersection gérée par des feux de circulation)
<b>A</b>	Excellent	≤ 10 sec.	≤ 10 sec.
<b>B</b>	Très bon	> 10 et ≤ 15 sec.	> 10 et ≤ 20 sec.
<b>C</b>	Bon	> 15 et ≤ 25 sec.	> 20 et ≤ 35 sec.
<b>D</b>	Acceptable	> 25 et ≤ 35 sec.	> 35 et ≤ 55 sec.
<b>E</b>	Difficile	> 35 et ≤ 50 sec.	> 55 et ≤ 80 sec.
<b>F</b>	Critique	> 50 sec.	> 80 sec.

L'analyse des conditions de circulation aux approches des différentes intersections du réseau routier à l'étude a été réalisée à l'aide des logiciels Synchro 11 et SimTraffic 11<sup>3</sup>. Les relevés de géométrie, les observations sur le terrain ainsi que les débits de circulation ont permis de calibrer le modèle Synchro afin de refléter le plus fidèlement possible les conditions actuelles des déplacements véhiculaires.

### 2.3.3 Résultats des simulations

À l'heure de pointe du matin, les simulations démontrent que l'état d'écoulement de la circulation est fluide sur les axes routiers avoisinant au site à l'étude avec des niveaux de service des mouvements qui s'établissent à B ou mieux. Pour autant, l'intersection Wellington/Bridge, située à l'extrémité est du secteur d'étude, affiche des conditions de circulation critiques (niveau de service F) à cause de la densité du débit pendulaire en provenance du pont Victoria et en direction du centre-ville.

À l'heure de pointe de l'après-midi, les conditions de circulation sont également fluides sur le réseau routier avoisinant au site du projet, avec des niveaux de service qui s'établissent à C ou mieux. C'est à l'intersection Bridge/Wellington où il est observé les conditions de circulation les plus difficiles (niveaux de service E et F), à cause de l'ampleur des mouvements pendulaires en direction du pont Victoria via la rue Bridge, alors que ce phénomène est accentué par les entraves et les détours causés par les travaux du REM. Ces conditions difficiles créent de l'interblocage aux débits à l'intersection du Centre/Wellington.

Ces conditions difficiles observées au carrefour Bridge/Wellington, aux heures de pointe du matin et de l'après-midi, constituent une problématique d'ordre régional qui relève directement du ministère des Transports et de la Mobilité durable et ses partenaires, dont les municipalités traversées par les rues Bridge et Wellington.

<sup>3</sup> Trafficware Corporation Synchro plus Simtraffic 11.



### 3. Situation future

#### 3.1 Projet

Le projet prévoit la construction de plusieurs bâtiments sur les îlots A et B du site Le Nordelec, lequel est ceinturé par les axes Saint-Patrick, Montmorency, Richardson et Shearer. L'îlot A, qui est existant, fait l'objet d'un agrandissement avec l'ajout de résidences et de bureaux. L'îlot B, dont le site est actuellement occupé en majorité par des aires de stationnement, abritera des bureaux et des commerces répartis sur plusieurs phases de construction (phase 1, phase 2A, phase 2B).

Le tableau 3.1 résume la typologie et la taille des usages prévus sur le site ainsi que l'offre en stationnement prévue pour chaque îlot, alors que la figure 3.1 montre la localisation de chaque îlot. À titre de rappel, le plan d'implantation détaillé du projet est présenté à l'annexe A.

Tableau 3.1 : Synthèse des usages et de l'offre en stationnement du projet

Site	Résidences (pi <sup>2</sup> )	Bureaux (pi <sup>2</sup> )	Commerces en (pi <sup>2</sup> )	Offre de stationnement
Îlot A-agrandissement (net)	162 054 (approx. 190 unités)	54 337		
Îlot B- Phase 1 (net)		199 914	15 000	301
Îlot B-Phase 2A (net)		258 957		304
Îlot B-phase 2B (net)		156 793	25 000	260
<b>TOTAL</b>	<b>162 054</b>	<b>670 001</b>	<b>40 000</b>	<b>865</b>

L'offre en stationnement du projet se chiffre à 865 cases, laquelle est répartie à travers les espaces souterrains des îlots B. Par ailleurs, un autre projet à proximité du site (îlot E) comporte une réserve de capacité de 100 cases de stationnement souterraines qui pourra desservir les usagers du projet. Ainsi donc, l'offre totale en stationnement disponible pour le projet s'évalue à 965 cases.

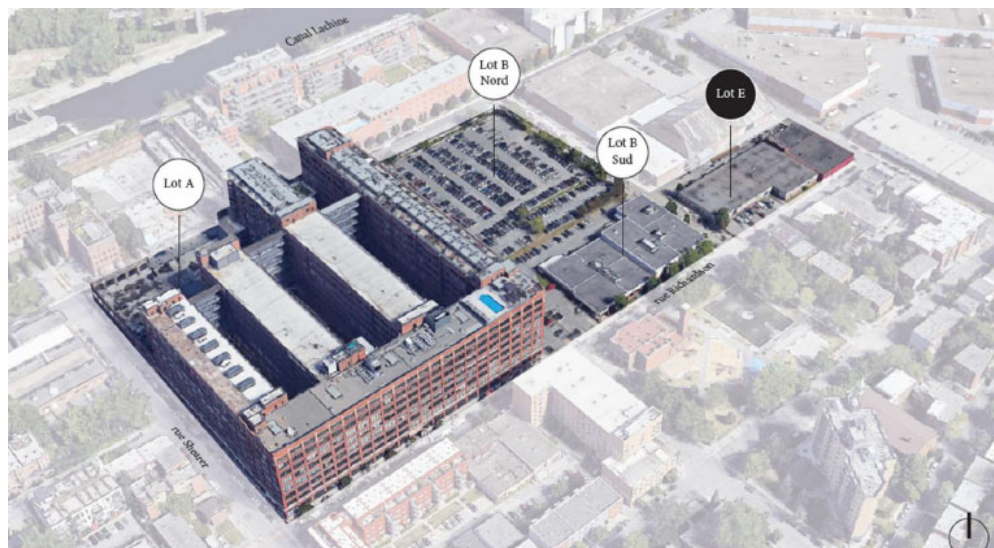

Figure 3.1 : Localisation des îlots du projet

## 3.2 Impacts sur les déplacements

### 3.2.1 Génération des déplacements

L'estimation des déplacements bruts générés par les bureaux du projet s'appuie sur des données provenant du manuel de référence Trip Generation Handbook (TGH), 11<sup>e</sup> édition<sup>4</sup>. Il s'agit d'une estimation théorique des déplacements engendrés par un tel projet. Les taux de génération représentent une moyenne pondérée de résultats d'études similaires réalisées pour des sites de fonctions semblables au Canada et aux États-Unis. Ces taux de génération supposent une utilisation exclusive (100 %) de l'automobile.

La catégorie « 222-Multifamily Housing (High-Rise) » a été utilisée pour générer les déplacements liés aux résidences, alors que la catégorie « 710-General Office Building » a servi de référence pour chiffrer les déplacements induits par les bureaux. Par ailleurs, les commerces de l'îlot B-Phase 1 ont été générés à l'aide de la catégorie « 822-Strip Retail Plaza », alors que ceux de la phase 2B ont été générés avec le code « 850-Supermarket ». Il est à noter que le nombre d'unités résidentielles a été estimé en fonction de la superficie de plancher (162 054 pi<sup>2</sup>) et d'un ratio moyen de 850 pi<sup>2</sup> par unité de logement, soit un total de 191 unités résidentielles.

Par ailleurs, afin de tenir compte des particularités du projet et du milieu dans lequel il est implanté, les hypothèses suivantes ont été appliquées à la génération des déplacements :

- + On considère des déplacements internes (échanges) entre les bureaux, les résidences et les commerces, alors que les taux d'échange ont été estimés à l'aide du manuel de référence du National Cooperative Highway Research Program (NCHRP)<sup>5</sup>. Il est estimé un taux de 6 % pour le matin et environ 7 % pour l'après-midi;
- + Les futurs usagers du projet adopteront un comportement des déplacements similaire à celui des usagers du quartier Sud-Ouest, soit le secteur 103 de l'enquête Origine-Destination (O-D) 2018 de l'ARTM. C'est ainsi que les parts modales révélées par l'EOD 2018 pour le Sud-Ouest ont été utilisées pour segmenter les déplacements nets externes générés par le projet. Il est à noter que les hypothèses sont conservatrices, car la part modale TC pourrait être en réalité plus élevée avec la bonification de l'offre TC liée à la mise en service du REM;
- + Les déplacements en « pass-by » ont été aussi pris en compte pour le marché d'alimentation avec un taux de 25 %. À titre informatif, un déplacement en « pass-by » constitue un arrêt intermédiaire au site pour profiter de la présence de commerces, sans aucune déviation de l'itinéraire.

Les tableaux 3.2 et 3.3 présentent les débits de circulation générés par le projet aux heures de pointe du matin et de l'après-midi respectivement, alors que le détail de l'exercice de génération est disponible à l'annexe C.

<sup>4</sup> Institute of Traffic Engineers, Trip Generation Manual, 11th Edition, Washington. D.C, 2021.

<sup>5</sup> National Cooperative Highway Research Program, Report 684 – Enhancing internal trip capture estimation for mixed-use developments, 2010.

Tableau 3.2 : Débits véhiculaires générés par le projet-Heure de pointe du matin

Période	Débits		
	Entrants (véh./h)	Sortants (véh./h)	Total (véh./h)
Îlot A-Agrandissement	47	14	61
Îlot B-Phase 1	147	23	170
Îlot B-Phase 2A	190	20	210
Îlot B-Phase 2B	131	26	157
Autre projet à proximité	100	16	116
<b>TOTAL</b>	<b>615</b>	<b>99</b>	<b>714</b>

Ce tableau permet de constater que le projet génère 714 véh./h à l'heure de pointe du matin, dont 615 en entrée et 99 en sortie. C'est l'îlot B-Phase 2A qui induit le plus de déplacements parce qu'il est doté d'une plus grande superficie de bureaux.

Tableau 3.3 : Débits véhiculaires générés par le projet-Heure de pointe de l'après-midi

Période	Débits		
	Entrants (véh./h)	Sortants (véh./h)	Total (véh./h)
Îlot A-Agrandissement	19	44	63
Îlot B-Phase 1	52	142	194
Îlot B-Phase 2A	38	162	200
Îlot B-Phase 2B	63	131	194
Autre projet à proximité	41	96	137
<b>TOTAL</b>	<b>213</b>	<b>575</b>	<b>788</b>

À l'heure de pointe de l'après-midi, les débits générés par le projet sont plus élevés que ceux du matin en raison des commerces qui induisent plus de déplacements durant cette période. Le débit total généré par le projet se chiffre à 788 véh./h, dont 213 entrants et 575 en sortie. À cause des bureaux, il est constaté un effet pendulaire, c'est-à-dire que la majorité des débits entre au site le matin et en ressort l'après-midi

### 3.2.2 Distribution et affectation des déplacements

Tout comme pour les parts modales, les résultats de l'enquête O-D 2018 ont été utilisés pour déterminer la distribution globale des déplacements entre le secteur d'étude (représenté par le secteur 103) et le reste de la région métropolitaine, agrégée en grandes origines et destinations.

Ce calcul suppose que les futurs occupants des bureaux du projet adopteront un comportement de déplacements similaire à celui des usagers actuels du quartier de Pointe-Saint-Charles. De plus, le calcul distingue les déplacements « attirés » par le projet, soit ceux ayant celui-ci comme destination, et ceux qui sont « produits » par le projet, donc ceux ayant le projet comme origine.

Tableau 3.4 : Distribution des déplacements générés par le projet aux périodes de pointe

Origine	Destination	Déplacements	
		% AM	% PM
Secteur d'étude (Sud-Ouest)	Couronne Nord et Laval	1 %	4 %
	Montréal centre et Ouest	37 %	29 %
	Montréal-Est	2 %	3 %
	Ouest-de-l'île-Vaudreuil-Soulanges	2 %	3 %
	Montréal centre-ville	25 %	8 %
	Secteur d'étude	29 %	43 %
	Couronne Sud et Rive Sud	4 %	11 %
<b>Total</b>		<b>100 %</b>	<b>100 %</b>
Couronne Nord et Laval	Secteur d'étude (Sud-Ouest)	4 %	1 %
Montréal centre et Ouest		32 %	34 %
Montréal-Est		3 %	1 %
Ouest-de-l'île-Vaudreuil-Soulanges		4 %	1 %
Montréal centre-ville		4 %	24 %
Secteur d'étude		40 %	35 %
Couronne Sud et Rive Sud		13 %	4 %
<b>Total</b>		<b>100 %</b>	<b>100 %</b>

Une lecture synthétique de ce tableau permet de constater, entre autres, que Montréal centre et Ouest, le centre-ville ainsi que le secteur d'étude (déplacements internes) sont les principales zones d'intérêts des usagers de l'arrondissement Sud-Ouest. En effet, 91 % des usagers originaires du secteur d'étude se destinent dans ces trois secteurs le matin, alors qu'en après-midi, où il est observé un effet miroir, 93 % des usagers se destinant dans le secteur d'étude proviennent de ces trois zones.

Des hypothèses sont considérées quant aux chemins concurrentiels empruntés par les usagers pour se déplacer entre le site du projet et les secteurs d'activités d'intérêts sus-évoqués.

### 3.2.3 Conditions de circulation anticipées

#### Mesures de mitigation

D'emblée, il est à mentionner que le réseau routier prévu à la suite de l'ouverture de l'antenne Rive-Sud du REM est considéré comme situation de référence, c'est-à-dire à la situation prévalant avant la mise en place des chemins de détour liés au chantier. Ensuite, les débits générés par le projet ont été ajoutés à ce réseau routier de référence pour la modélisation des conditions de circulation prévisible à l'ultime avec le projet.

Par ailleurs, afin de minimiser les impacts du projet sur le réseau routier adjacent, les mesures de mitigation suivantes ont été proposées :

- + Optimisation de minutages à l'intersection Saint-Patrick/Montmorency pour les heures de pointe du matin et de l'après-midi, et ce, sans modifier la longueur du cycle ni impacter le temps de traversée des piétons;
- + Optimisation de minutages à l'intersection Saint-Patrick/des Seigneurs pour les heures de pointe du matin et de l'après-midi, mais sans impacter le temps de traversée des piétons;
- + Interdiction du stationnement sur la rue Montmorency, entre l'accès au stationnement prévu sur cette rue et la rue Saint-Patrick (longueur de 25 m). Cela équivaut à la perte d'environ 8 cases de stationnement sur rue. Cette mesure permet de dégager la visibilité au niveau de cet accès tout en facilitant les mouvements d'entrée et de sortie du stationnement.

#### Résultats des simulations

À l'heure de pointe du matin, l'état d'écoulement de la circulation anticipée est acceptable sur le réseau routier avoisinant au site à l'étude avec des niveaux de service qui s'établissent à D ou mieux. Cela démontre la pertinence des mesures de mitigation proposées pour minimiser les impacts du projet. L'intersection des rues Bridge et Wellington affiche également des conditions acceptables à cause des mesures de mitigation d'ordre opérationnel proposées dans le cadre du projet du REM.

À l'heure de pointe de l'après-midi où les débits générés par le projet sont plus élevés, les conditions de circulation sur les axes routiers avoisinants au site sont acceptables (niveau de service D ou mieux), sauf à des Seigneurs où un niveau de service E est observé. L'intersection des rues Bridge et Wellington, située plus à l'est du secteur d'étude, affiche des conditions plus difficiles comme c'est le cas actuellement (niveaux de service E et F), à cause de la densité des mouvements pendulaires qui s'effectuent entre le centre-ville de Montréal et la Rive-Sud via le pont Victoria.

Les conditions de circulation anticipées à l'heure de pointe du matin et celle de l'après-midi sont respectivement illustrées aux figures 3.2 et 3.3.

Le détail des simulations est disponible à l'annexe D.



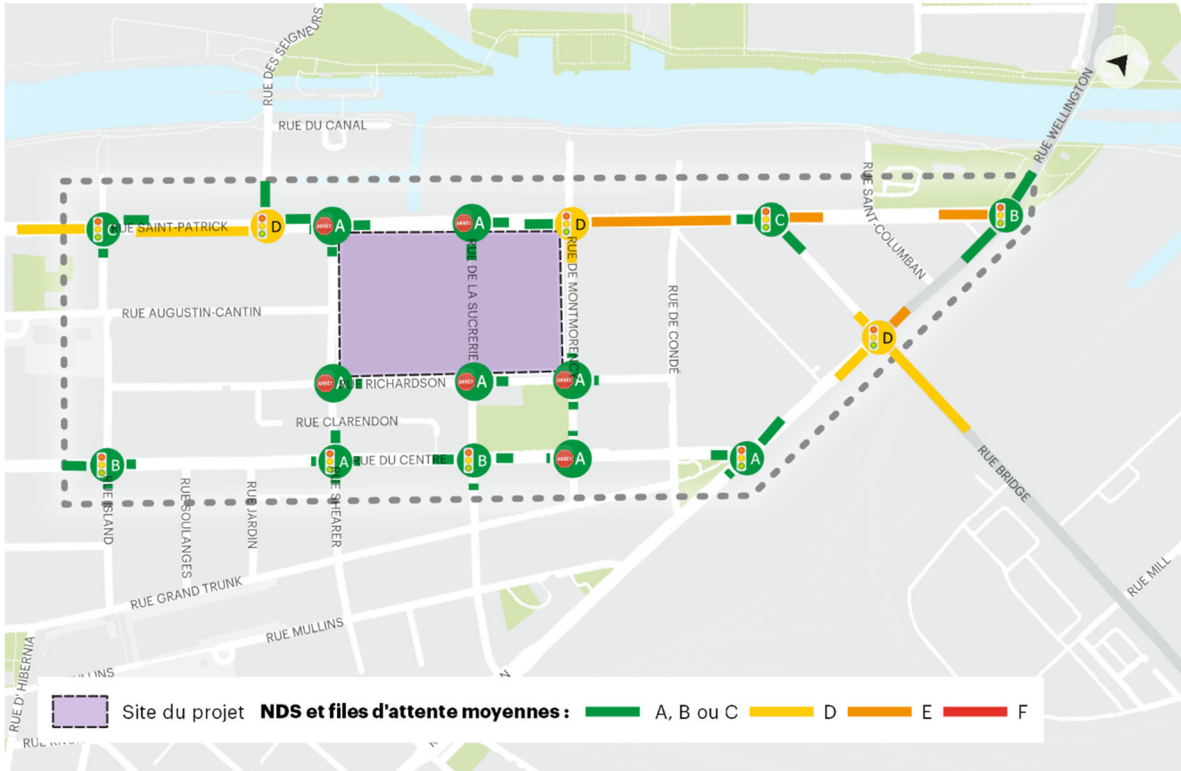

Figure 3.2 : Conditions de circulation anticipées – Heure de pointe du matin

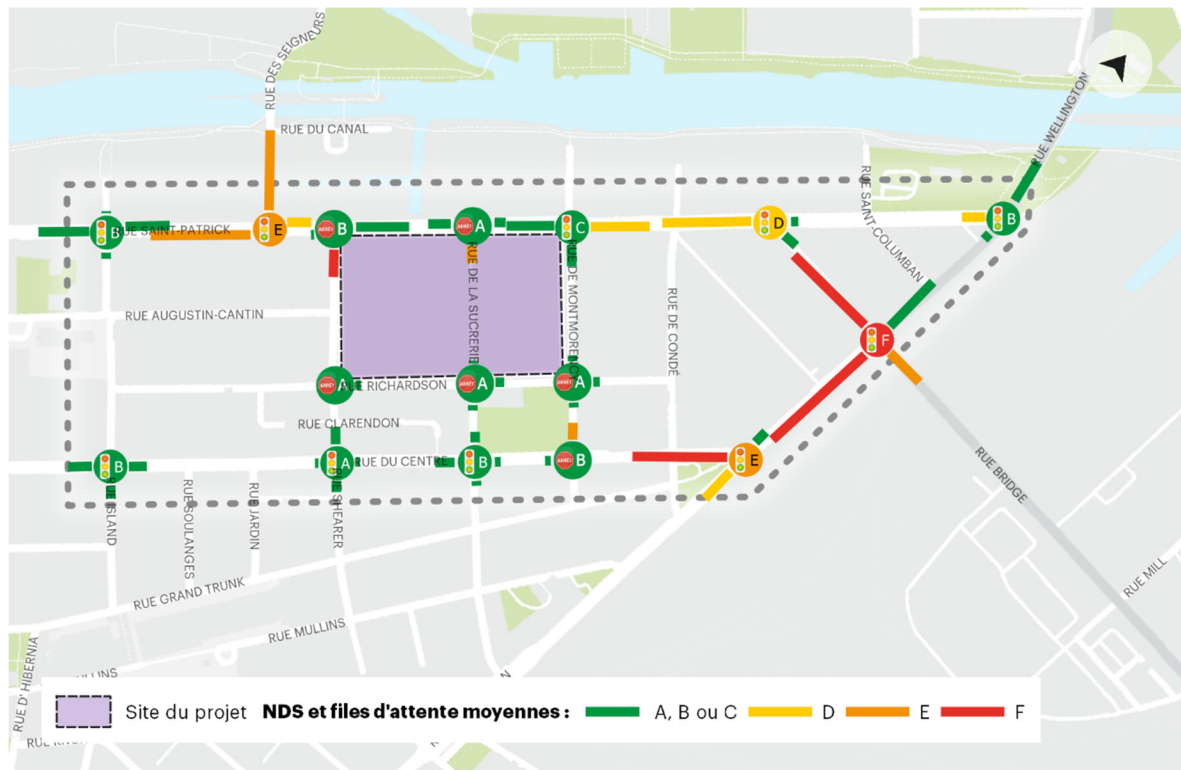

Figure 3.3 : Conditions de circulation anticipées – Heure de pointe de l'après-midi

### 3.3 Fonctionnalité du site

#### 3.3.1 Nombre et localisation des accès

Selon le plan d'implantation fourni par le promoteur, les îlots A et B du projet sont dotés des accès suivants:

- + Îlot A : un accès bidirectionnel situé sur la portion nord de la rue privée de la Sucrierie;
- + Îlot B-Phase 2B : un accès bidirectionnel situé sur la rue Montmorency;
- + Îlot B-Phases 1 et 2A : un accès bidirectionnel accessible depuis la portion sud de la rue privée de la Sucrierie. Il est à noter que le stationnement de la phase 2A est accessible depuis celui de la phase 1 où sont aménagés les accès susmentionnés.

Les distances de dégagement de ces accès par rapport aux intersections limitrophes respectent le dégagement minimal (15 m) prescrit par le guide canadien de conception géométrique des routes de l'Association des Transports du Canada (ATC).

Enfin, il est prévu un quai de déchargement dans l'îlot B-Phase 1, lequel est accessible via la portion sud de la rue privée de la Sucrierie et se situe au nord de l'accès au stationnement pour les phases 1 et 2A. Les manœuvres de recul des camions de livraison s'effectuent donc sur la rue privée de la Sucrierie.

#### 3.3.2 Dégagement de la visibilité aux accès

Afin d'assurer la visibilité à l'accès, les espèces utilisées pour l'aménagement paysager, de même que les accumulations de neige en bordure de rue en période hivernale, ne doivent pas obstruer le corridor visuel des conducteurs, qui se situe entre 1 et 1,8 m par rapport au sol (voir figure ci-dessous).

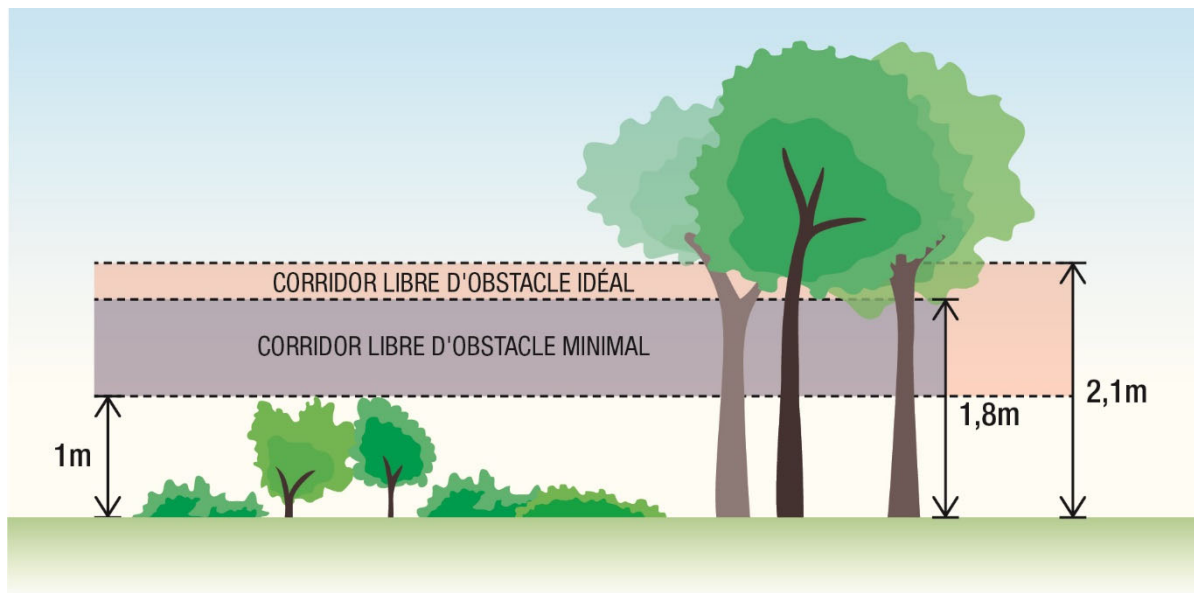

Figure 3.4 : Corridor libre d'obstacle

## 3.4 Le stationnement

### 3.4.1 Offre de stationnement proposée versus le règlement d'urbanisme

Selon le plan d'implantation et le tableau des statistiques fournis par le promoteur, il est prévu une offre cumulative de 965 cases de stationnement souterraines, lesquelles sont réparties à travers les îlots du site du projet. Il est important de mentionner que ces stationnements desserviront à la fois les usages actuels de l'îlot A (42 000 pi<sup>2</sup> commercial et 787 000 pi<sup>2</sup> de bureaux) ainsi que les futurs usages de l'îlot B tels que décrits dans la présente étude. Rappelons que l'îlot B actuel est occupé par environ 500 cases de stationnement extérieures ainsi que d'un immeuble totalisant 33 000 pi<sup>2</sup> de bureaux.

Selon le règlement de zonage de l'arrondissement Sud-Ouest (01-280), le projet devrait offrir un minimum d'une case par groupe de deux logements et un maximum de 1,5 unité par logement pour les résidences. Pour les bureaux, le règlement préconise un nombre minimal d'une unité par 200 m<sup>2</sup> et un maximum d'une case par 100 m<sup>2</sup>, alors que pour les commerces, il est exigé un nombre minimal de 1 unité par 200 m<sup>2</sup> et un nombre maximal d'une unité par 75 m<sup>2</sup>.

Le tableau ci-dessous synthétise l'offre proposée par le projet versus celles exigées par le règlement d'urbanisme.

Tableau 3.5 : Offre de stationnement exigée versus celle proposée pour le projet

Site	Offre exigée par l'arrondissement Sud-Ouest		Offre proposée par le projet
	Min.	Max.	
Îlot A - actuel	263	784	75
Îlot A-Agrandissement	112	178	0
Îlot B- Phase 1	69	204	301
Îlot B-Phase 2A	80	241	304
Îlot B-phase 2B	60	177	360
<b>TOTAL</b>	<b>585</b>	<b>1 583</b>	<b>1 040</b>

Ce tableau permet de constater que l'offre en stationnement des îlots A et B du projet du Nordelec, dans leur ensemble, respecte pleinement les exigences de l'arrondissement. Cette offre, plus généreuse que celle minimale prescrite par le règlement d'urbanisme permet quand même de desservir toute la demande en stationnement et évite ainsi des débordements sur les rues avoisinantes au site du projet, comme démontré à la section suivante. De plus, l'offre excédentaire peut être mise à la disposition des résidents et autres usagers du quartier afin de pallier la demande de stationnement sur rue en dehors des heures d'achalandage des bureaux.

### 3.4.2 Demande de stationnement

Pour estimer la demande de stationnement pour le projet multifonctionnel le Nordelec, CIMA+ a conçu un outil de calcul basé sur les principes du *Shared Parking* de l'*Urban Land Institute* afin de prendre en compte tous les facteurs influençant la demande réelle en stationnement. Compte tenu des usages complémentaires, il est possible d'optimiser les espaces de stationnement pour éviter le surdimensionnement des infrastructures.

### 3.4.2.1 Méthodologie et hypothèses d'estimation

La méthodologie d'estimation de la demande de stationnement se résume comme suit :

- + Estimation de la demande brute, basée sur les taux bruts prescrits par le manuel *Parking Generation* de l'ITE pour chacun des usages du projet;
- + Ajustement de la demande brute en fonction des taux d'occupation du stationnement liés à l'heure et au type de journée (semaine ou fin de semaine), et ce, pour chaque usage;
- + La fréquentation actuelle (situation postpandémie) des bureaux serait de 54 %<sup>6</sup> plus faible que celle observée avant la pandémie, à cause du télétravail adopté par plusieurs entreprises;
- + Enfin, il est effectué l'adéquation entre la demande maximale totale instantanée (tous usages confondus) et l'offre de stationnement proposée afin de déterminer si cette dernière est excédentaire ou déficitaire par rapport à la demande, puis proposer des mesures de mitigation, si requis.

### 3.4.2.2 Résultats

La figure ci-dessous démontre la variation de demande maximale instantanée estimée pour une journée de semaine typique, par rapport à l'offre maximale proposée pour le projet. Le détail des analyses, indiquant aussi la demande en fin de semaine, est illustré à l'annexe E.

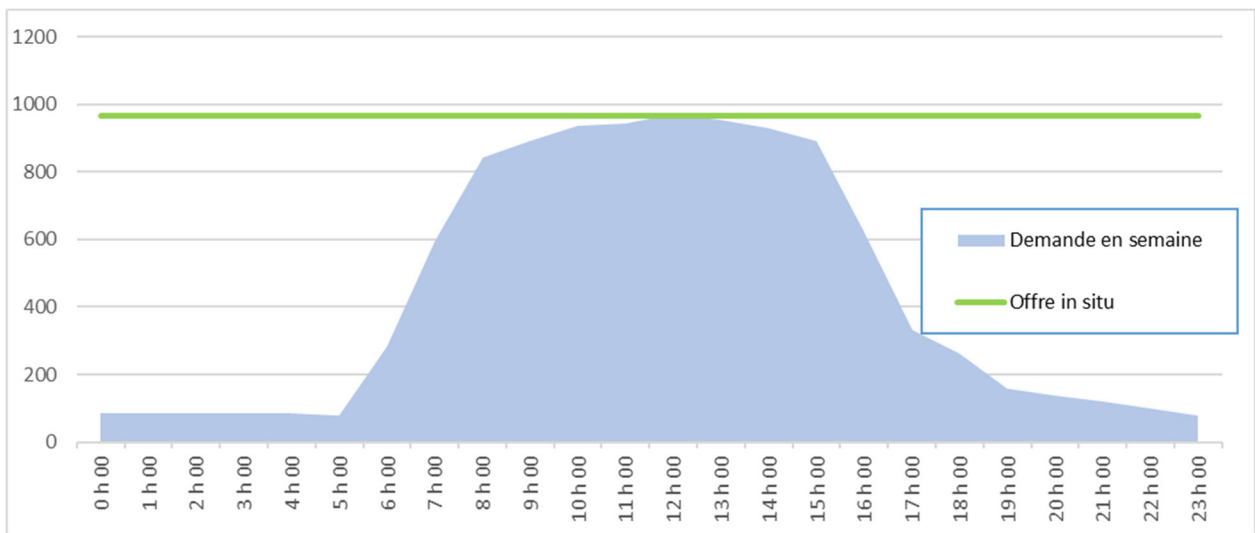

Figure 3.5 : Demande instantanée théorique en stationnement – Jour de semaine typique

Il est constaté entre autres que l'offre cumulative de stationnement proposée pour le projet (965 cases) satisfait globalement la demande maximale instantanée de stationnement pour une journée typique de semaine. Ainsi, il n'est anticipé aucun débordement de la demande de stationnement généré par le projet sur les rues avoisinantes au site du projet.

<sup>6</sup> <https://www.lapresse.ca/affaires/entreprises/2022-10-12/sondage-de-la-ccmm/la-majorite-des-travailleurs-reviennent-au-moins-une-journee-par-semaine-a-montreal.php>

Qui plus est, le plan de gestion des déplacements proposé (section 4) présente des mesures incitatives pertinentes permettant de diminuer la dépendance à l'automobile au profit des modes actifs et collectif, en conformité avec les orientations et exigences du plan de transport de la Ville de Montréal.

Enfin, il est bon de rappeler que les nombreuses cases dédiées aux bureaux pourraient être utilisées par les résidents du secteur durant les périodes où ces bureaux ne sont pas opérationnels (le soir ou fin de semaine). En sus, cette offre hors rue, disponible le soir et les fins de semaine, diminuerait la pression sur le stationnement sur rue en période hivernale, laquelle est engendrée par les interdictions occasionnées par les opérations de déneigement.

## 4. Plan de gestion des déplacements

### 4.1 Objectifs du plan de gestion des déplacements

La mise sur pied d'un plan de gestion des déplacements vise à réduire la dépendance liée aux déplacements effectués en auto-solo. Diverses mesures peuvent être prises afin d'atteindre les objectifs suivants :

- + Susciter l'envie d'utiliser les modes de transports alternatifs à l'auto-solo et sensibiliser la population aux bienfaits qu'ils procurent;
- + Réduire l'impact de la circulation automobile sur les résidents, les commerçants et les citoyens en offrant des infrastructures garantissant une bonne accessibilité au site par des moyens de transports collectifs et actifs.

La mise en place de mesures incitatives et l'amélioration (qualitative et quantitative) de l'offre en infrastructures doivent être effectuées simultanément afin d'encourager les usagers à utiliser des modes alternatifs à l'auto-solo.

### 4.2 Avantages du plan d'implantation

L'analyse du plan d'implantation permet de constater que le projet à l'étude s'insère déjà dans un cadre favorable à la limitation de l'impact des déplacements automobile en ce qui a trait aux aspects suivants :

#### Localisation générale du site

- + Proximité de plusieurs zones d'intérêts de l'arrondissement Sud-Ouest qui est un quartier central offrant plusieurs opportunités d'emplois et de services divers;
- + Proximité du site au réseau supérieur (route 112, autoroute Bonaventure, A-15, pont Champlain) favorisant ainsi un accès direct au réseau autoroutier afin de rallier entre autres les grandes zones d'intérêts, dont le centre-ville de Montréal et ses environs;
- + Proximité du canal de Lachine et de plusieurs parcs qui bordent ce canal, soit des sites d'intérêts offrant un cadre de vie agréable et invitant.

## Stationnement véhiculaire

- + Localisation des cases de stationnement du projet dans des espaces de stationnements souterrains, ce qui limite les îlots de chaleur et optimise l'espace pour la densification du secteur en conformité avec les orientations du plan d'urbanisme du Sud-Ouest;
- + L'offre de stationnement satisfait la demande maximale instantanée, ce qui évite les débordements sur rue;
- + L'offre de stationnement dédiée aux bureaux pourrait être utilisée par les résidents du secteur durant les périodes où ces bureaux ne sont pas opérationnels (le soir ou fin de semaine). En sus, cette offre hors rue, disponible le soir et les fins de semaine, diminuerait la pression sur le stationnement sur rue en période hivernale, laquelle est engendrée par les interdictions occasionnées par les opérations de déneigement;

## Modes collectifs et actifs

- + Proximité ( $\pm 800$  m) de la station de métro Charlevoix (ligne verte) dont l'accès est facilité par les autobus de rabattement de la STM, et  $\pm 1,5$  km de la station Georges-Vanier (ligne orange), soit les deux principales lignes de métro permettant d'accéder au centre-ville et ses environs; on note aussi la station anticipée Griffintown-Bernard-Landry du REM à  $\pm 2$  km du site à l'étude;
- + Présence de plusieurs lignes d'autobus dans le secteur d'étude, lesquelles se situent entre autres sur les rues centre, Wellington et Saint-Patrick. Certaines de ces lignes se rabattent vers la station de métro Charlevoix de la ligne verte;
- + Présence de trottoirs des deux côtés de tous les axes municipaux entourant le site, favorisant ainsi des déplacements à pieds confortables et sécuritaires;
- + Présence d'aménagements actifs structurants, soit une piste cyclable bidirectionnelle et une chaussée pour piétons, de part et d'autre du canal;
- + Proximité de trois stations BIXI, dont deux sont avoisinantes au site du projet (Montmorency/Richardson, Shearer/Augustin-Cantin<sup>7</sup>).

## 4.3 Mesures incitatives

Plusieurs mesures d'accompagnement peuvent appuyer les efforts dans l'aménagement du site afin de favoriser l'utilisation des modes actifs dans les déplacements. Le tableau 4.1 dresse une liste (non exhaustive) de mesures et présente celles qui sont appropriées pour les différents usages prévus pour le projet Le Nordelec.

Les Centres de gestion des déplacements peuvent fournir de l'assistance dans la mise en application des mesures retenues.

<sup>7</sup> Rue est-ouest, située entre Richardson et Saint-Patrick.

Tableau 4.1 : Mesures appropriées dans le cadre du plan de gestion des déplacements

Mesures incitatives potentielles	Mesures recommandées pour le projet		
	Résidences	Commerces	Bureaux
<b>Transport en commun</b>			
Entamer les discussions avec la STM afin que certaines lignes d'autobus desservant le secteur d'étude offrent des services de rabattement à la future station Griffintown-Bernard-Landry du REM, et permettre ainsi aux usagers du secteur d'avoir un accès direct au centre-ville et à la Rive-Sud via un mode lourd.	✓		✓
<b>Aménager les futurs arrêts d'autobus près des portes d'entrée du site, accessibles par des liens piétons directs.</b>	✓	✓	✓
Offrir des infrastructures sécuritaires et conviviales, telles que des éléments de mobilier urbain, en quantité et qualité suffisantes, au niveau des arrêts d'autobus.	✓	✓	✓
Inciter les employés à utiliser le transport en commun et fidéliser la clientèle. (Ex. : abonnement payé en tout ou en partie par l'employeur, tirage de titres de transport, abonnement à l'essai pour une période d'un à trois mois).		✓	✓
Informers les usagers du projet sur l'offre spéciale de exo et de la STM concernant la carte Opus Plus <sup>8</sup> : Offre de la STM pour le transport sur l'île de Montréal uniquement : <a href="https://www.stm.info/fr/offres-speciales/mobilite-integree">https://www.stm.info/fr/offres-speciales/mobilite-integree</a> Offre de exo pour le transport sur l'île et dans les couronnes : <a href="https://exo.quebec/fr/titres-tarifs/abonnements">https://exo.quebec/fr/titres-tarifs/abonnements</a>	✓	✓	✓
<b>Vélo</b>			
Mise en place d'une flotte de vélos en libre-service.	✓		✓
Aménagement de supports à vélo de qualité et en nombre suffisant.	✓	✓	✓
Accès sécuritaire et abrité aux bâtiments et éclairé.	✓	✓	✓
Offrir des commodités en nombre suffisant pour accommoder les usagers des transports actifs (vestiaires, douches, casiers, etc.), conformément aux recommandations de Vélo Québec.		✓	✓
<b>Marche</b>			
Assurer la sécurité des piétons sur le site.	✓	✓	✓
Programmes de récompense.		✓	✓
Faciliter la formation de groupes de marche parmi les résidents.	✓		
<b>Covoiturage</b>			
Développer un outil pour faciliter le jumelage des employés.		✓	✓
Retour garanti à domicile pour les employés.		✓	✓
Stationnements privilégiés réservés aux covoitureurs.		✓	✓
<b>Électrification des transports</b>			

<sup>8</sup> OPUS+ est un abonnement à un titre de transport d'une durée indéterminée qui permet de voyager avec une carte OPUS tout en profitant d'une gamme d'avantages.

Mesures incitatives potentielles	Mesures recommandées pour le projet		
	Résidences	Commerces	Bureaux
Installer des bornes de recharge pour véhicules électriques. Hydro-Québec par le biais de son programme « circuit électrique » aide les entreprises à concevoir les appels d'offres nécessaires pour l'installation de borne ouverte au public (pas de subvention).	✓	✓	✓

Enfin, pour assurer le confort et la sécurité de la circulation piétonnière, le projet devra respecter les principes d'aménagement de la charte du piéton de Montréal<sup>9</sup> en termes de largeurs de trottoirs, de traverses piétonnes et d'accès pour les personnes à mobilité réduite.

<sup>9</sup> Ville de Montréal (juin 2006). *Plan de transport de Montréal – Charte du piéton*. Document de consultation, 6 p.



## 5. Conclusion

La firme CIMA+ a été mandatée par ALLIED afin de réaliser une étude d'impact sur les déplacements en lien avec les îlots A (agrandissement) et B (phases 1, 2A et 2B) du projet du Nordelec, lesquels se situent dans le quadrilatère délimité par les rues Saint-Patrick, Shearer, Richardson et Montmorency, dans l'arrondissement Sud-Ouest de Montréal.

CIMA+ a réalisé l'étude d'impact sur les déplacements à travers trois volets, soit le portrait de la situation actuelle, l'analyse de la situation future et l'élaboration d'un plan de gestion des déplacements.

Les analyses démontrent que la desserte en transport collectif et actif du secteur d'étude est bonne, alors que les conditions de circulation anticipées dans le secteur limitrophe au site du projet sont globalement acceptables avec la majorité des niveaux de service qui s'évalue à D ou mieux. Ces conditions acceptables découlent des mesures de mitigation d'ordre opérationnel suivantes : optimisation des minutages dans l'axe Saint-Patrick aux intersections des rues Montmorency et des Seigneurs. Il est aussi proposé d'éliminer le stationnement sur la rue Montmorency, entre l'accès du projet et Saint-Patrick, afin de dégager la visibilité. Par ailleurs, les conditions de circulation observées à l'intersection Bridge/Wellington située plus à l'est du site du projet demeurent difficiles en après-midi (niveaux de service E et F), comme c'est le cas actuellement. Ces conditions difficiles, occasionnées par les forts débits pendulaires entre la Rive-Sud et le centre-ville de Montréal, constituent une problématique d'ordre régional qui relève directement du ministère des Transports et de la Mobilité durable et ses partenaires.

L'offre de stationnement du projet dans son ensemble (965 cases) respecte les seuils imposés par le règlement de l'urbanisme de l'arrondissement, de même que celle-ci permet de satisfaire la demande maximale instantanée et d'éviter ainsi des débordements sur les rues avoisinantes au site du projet. Qui plus est, CIMA+ a proposé un plan de gestion des déplacements, lequel présente des mesures incitatives pertinentes permettant de diminuer la dépendance à l'automobile au profit des modes actifs et collectif, en conformité avec les orientations et exigences du plan de transport de la Ville de Montréal.

Enfin, il est bon de rappeler que les cases dédiées aux bureaux pourraient être utilisées par les résidents du secteur durant les périodes où ces bureaux ne sont pas opérationnels (le soir ou fin de semaine). En sus, cette offre hors rue, disponible le soir et les fins de semaine, diminuerait la pression sur le stationnement sur rue en période hivernale, laquelle est engendrée par les interdictions occasionnées par les opérations de déneigement.

À la lumière des analyses effectuées, le projet du Nordelec, soit l'agrandissement de l'îlot A et la construction de l'îlot B (phases 1, 2A et 2B), est réalisable si les mesures de mitigation proposées sont appliquées avant la mise en œuvre du projet.

# A

## Annexe A Plan d'implantation du projet

# Plan de site

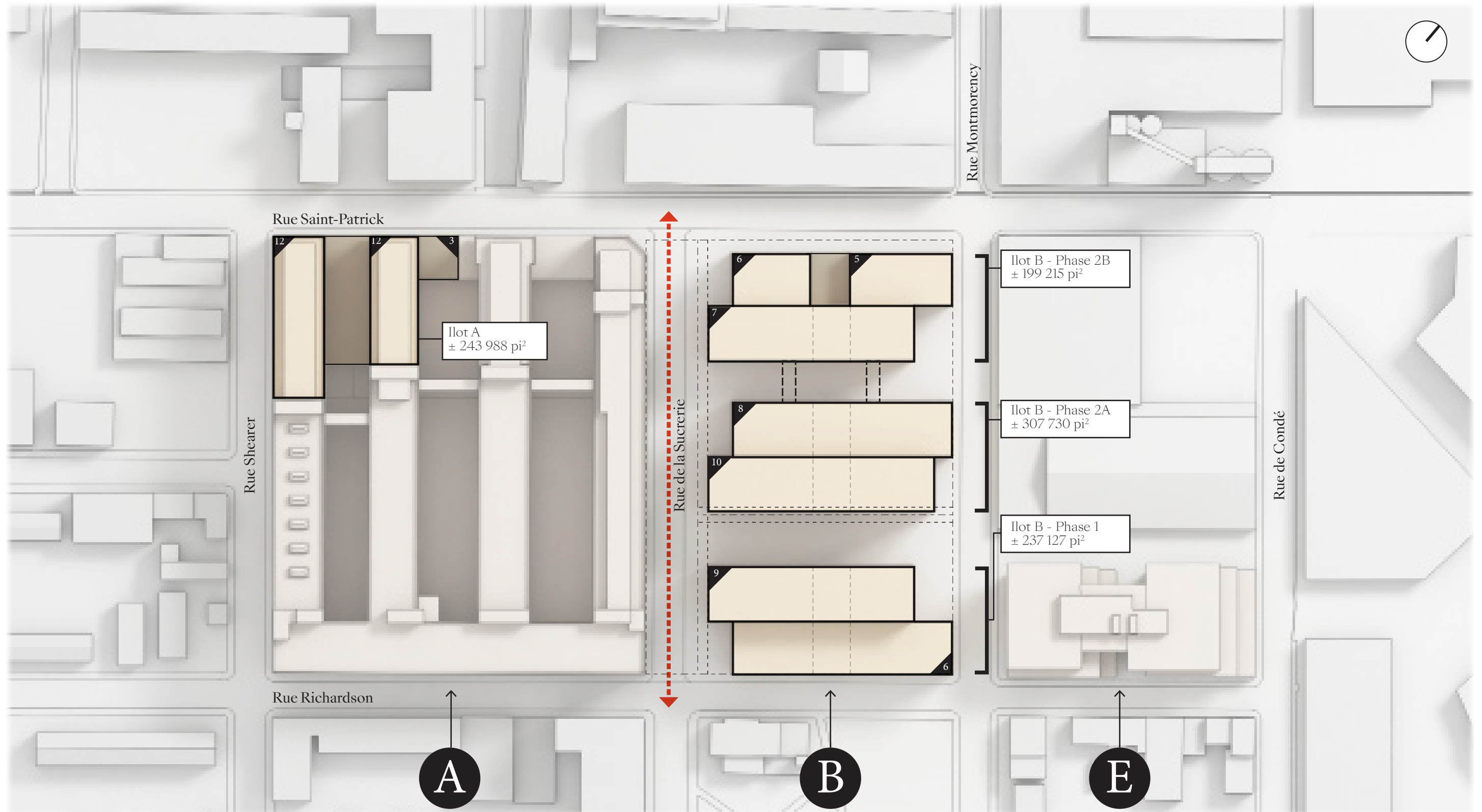

Nordelec Article 89

## Accès au site

### Stationnement PA

Accès depuis la portion nord de la future rue privée de la Sucrierie. Rue de la Sucrierie à double sens en impasse, donnant sur la rue Saint-Patrick à double sens et ouvert au camionnage.

### Stationnement PE

Accès depuis la rue de Condé. Rue à double sens ouvert au camionnage.

### Stationnement Îlot B Sud

Accessible depuis la portion sud de la future rue privée de la Sucrierie. Rue de la Sucrierie à double sens en impasse, donnant sur la rue Richardson (sens unique vers l'ouest) et la portion publique de la rue de la Sucrierie (double sens). Les rues Richardson et Sucrierie sont interdites aux camions exceptés livraison locale.

### Stationnement Îlot B Nord

Accessible depuis la rue Montmorency. Rue à double sens et interdite aux camions exceptés livraison locale. Piste cyclable en marge des deux voies de la rue Montmorency.

### Quai de chargement Îlot B

Accessible depuis la nouvelle rue privée de la Sucrierie. Maneuvres de camions extérieurs sur rue privée.

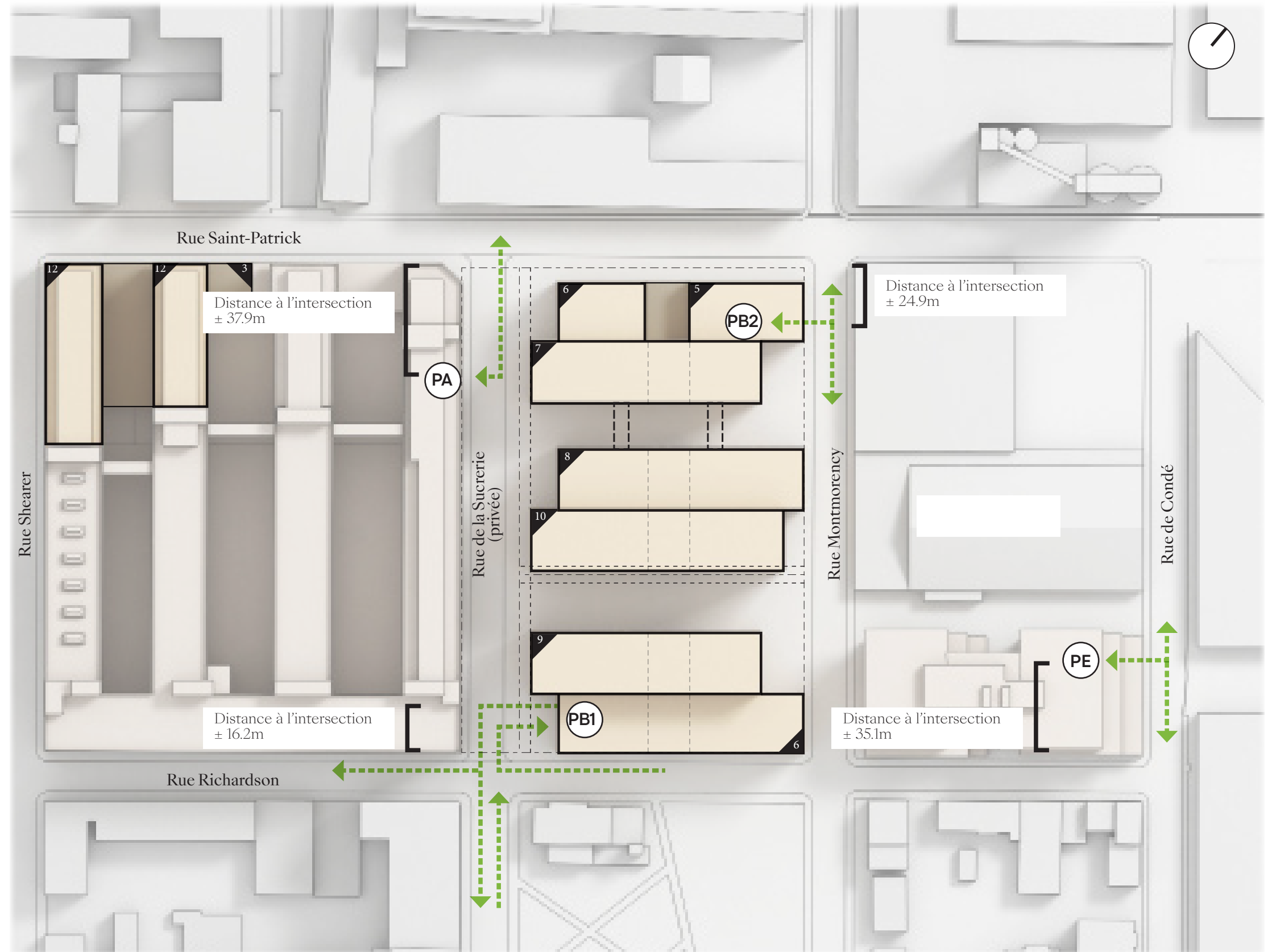

# B

## Annexe B Détail des simulations de l'actuel



**1: rue St-Patrick & rue Charlevoix Performance by approach**

Approach	EB	WB	NB	SB	All
Denied Delay (hr)	0.1	0.0	0.1	0.0	0.1
Denied Del/Veh (s)	0.4	0.0	0.5	0.2	0.3
Total Delay (hr)	5.5	0.9	5.1	1.7	13.3
Total Del/Veh (s)	33.1	8.2	47.6	26.4	29.4
Vehicles Entered	586	396	384	230	1596
Vehicles Exited	590	398	377	228	1593
Hourly Exit Rate	590	398	377	228	1593
Input Volume	584	389	383	223	1579
% of Volume	101	102	98	102	101

**2: des Seigneurs & St-Patrick Performance by approach**

Approach	EB	WB	SB	All
Denied Delay (hr)	0.4	0.1	0.2	0.6
Denied Del/Veh (s)	2.9	0.5	1.3	1.6
Total Delay (hr)	13.0	2.7	9.1	24.8
Total Del/Veh (s)	94.7	24.1	73.0	66.6
Vehicles Entered	487	392	439	1318
Vehicles Exited	472	394	433	1299
Hourly Exit Rate	472	394	433	1299
Input Volume	522	378	454	1354
% of Volume	90	104	95	96

**3: Shearer/Accès & St-Patrick Performance by approach**

Approach	EB	WB	NB	All
Denied Delay (hr)	1.5	0.0	0.1	1.5
Denied Del/Veh (s)	6.8	0.1	2.3	4.5
Total Delay (hr)	3.4	0.3	1.8	5.5
Total Del/Veh (s)	15.8	3.7	57.8	16.2
Vehicles Entered	768	336	110	1214
Vehicles Exited	763	336	106	1205
Hourly Exit Rate	763	336	106	1205
Input Volume	835	329	101	1265
% of Volume	91	102	105	95

**4: St-Patrick Performance by approach**

Approach	EB	WB	NB	All
Denied Delay (hr)	17.4	0.0	0.0	17.4
Denied Del/Veh (s)	77.7	0.1	0.0	55.3
Total Delay (hr)	13.4	0.4	2.4	16.1
Total Del/Veh (s)	62.3	4.1	534.4	52.6
Vehicles Entered	764	313	15	1092
Vehicles Exited	757	312	10	1079
Hourly Exit Rate	757	312	10	1079
Input Volume	870	309	19	1198
% of Volume	87	101	53	90

**5: Montmorency & St-Patrick Performance by approach**

Approach	EB	WB	NB	SB	All
Denied Delay (hr)	43.7	0.0	0.0	0.0	43.7
Denied Del/Veh (s)	204.7	0.0	0.1	0.1	130.9
Total Delay (hr)	10.7	2.6	0.4	0.1	13.7
Total Del/Veh (s)	55.5	25.5	22.8	23.5	43.7
Vehicles Entered	684	358	60	15	1117
Vehicles Exited	683	358	59	15	1115
Hourly Exit Rate	683	358	59	15	1115
Input Volume	869	361	62	12	1304
% of Volume	79	99	95	125	86

**6: Rue Bridge & Rue Saint-Patrick Performance by approach**

Approach	EB	WB	NB	All
Denied Delay (hr)	0.0	0.0	0.0	0.0
Denied Del/Veh (s)	0.0	0.0	0.0	0.0
Total Delay (hr)	19.2	7.6	1.1	27.8
Total Del/Veh (s)	96.6	24.2	16.4	48.2
Vehicles Entered	695	1107	235	2037
Vehicles Exited	692	1108	235	2035
Hourly Exit Rate	692	1108	235	2035
Input Volume	873	1111	239	2223
% of Volume	79	100	98	92

**7: Rue Wellington & Rue Saint-Patrick Performance by approach**

Approach	NB	SB	All
Denied Delay (hr)	0.0	0.5	0.5
Denied Del/Veh (s)	0.0	1.5	1.1
Total Delay (hr)	0.2	2.9	3.0
Total Del/Veh (s)	1.3	9.3	7.0
Vehicles Entered	442	1105	1547
Vehicles Exited	441	1104	1545
Hourly Exit Rate	441	1104	1545
Input Volume	492	1107	1599
% of Volume	90	100	97

**8: rue Charlevoix & Rue Centre Performance by approach**

Approach	EB	WB	NB	SB	All
Denied Delay (hr)	0.0	0.0	0.0	0.0	0.0
Denied Del/Veh (s)	0.2	0.0	0.2	0.0	0.2
Total Delay (hr)	1.8	0.5	1.1	0.5	3.9
Total Del/Veh (s)	18.4	20.0	14.6	11.9	16.2
Vehicles Entered	339	93	258	154	844
Vehicles Exited	339	94	259	154	846
Hourly Exit Rate	339	94	259	154	846
Input Volume	333	99	256	150	838
% of Volume	102	95	101	103	101

**9: rue Sucrierie Performance by approach**

Approach	EB	NB	SB	All
Denied Delay (hr)	0.0	0.0	0.0	0.0
Denied Del/Veh (s)	0.1	0.1	0.0	0.1
Total Delay (hr)	0.0	0.0	0.0	0.0
Total Del/Veh (s)	4.7	3.0	0.3	2.0
Vehicles Entered	19	26	44	89
Vehicles Exited	19	26	44	89
Hourly Exit Rate	19	26	44	89
Input Volume	21	27	48	96
% of Volume	90	96	92	93



---

**10: Montmorency Performance by approach**

---

Approach	NB	SB	All
Denied Delay (hr)	0.0	0.0	0.0
Denied Del/Veh (s)	0.0	0.0	0.0
Total Delay (hr)	0.0	0.0	0.0
Total Del/Veh (s)	0.0	0.6	0.5
Vehicles Entered	10	82	92
Vehicles Exited	10	83	93
Hourly Exit Rate	10	83	93
Input Volume	12	86	98
% of Volume	83	97	95

---

**11: Montmorency Performance by approach**

---

Approach	NB	SB	All
Denied Delay (hr)	0.0	0.0	0.0
Denied Del/Veh (s)	0.0	0.0	0.0
Total Delay (hr)	0.0	0.0	0.0
Total Del/Veh (s)	1.1	0.0	0.2
Vehicles Entered	10	83	93
Vehicles Exited	10	83	93
Hourly Exit Rate	10	83	93
Input Volume	12	86	98
% of Volume	83	97	95

---

**12: Shearer & Centre Performance by approach**

---

Approach	EB	WB	NB	SB	All
Denied Delay (hr)	0.0	0.0	0.0	2.1	2.1
Denied Del/Veh (s)	0.0	0.0	0.2	45.2	15.8
Total Delay (hr)	1.3	0.1	0.3	2.0	3.7
Total Del/Veh (s)	21.3	7.0	20.2	44.3	27.3
Vehicles Entered	215	51	52	159	477
Vehicles Exited	214	52	51	155	472
Hourly Exit Rate	214	52	51	155	472
Input Volume	210	60	47	178	495
% of Volume	102	87	109	87	95

**13: rue Sucrierie & Centre Performance by approach**

Approach	EB	WB	NB	SB	All
Denied Delay (hr)	0.7	0.0	0.0	0.1	0.8
Denied Del/Veh (s)	13.7	0.0	0.1	3.8	7.4
Total Delay (hr)	6.1	0.1	0.4	1.0	7.6
Total Del/Veh (s)	113.5	6.0	29.8	48.1	68.5
Vehicles Entered	192	88	43	73	396
Vehicles Exited	177	88	43	71	379
Hourly Exit Rate	177	88	43	71	379
Input Volume	201	90	42	78	411
% of Volume	88	98	102	91	92

**14: rue Centre/Centre Performance by approach**

Approach	EB	WB	SB	All
Denied Delay (hr)	0.0	0.0	0.0	0.0
Denied Del/Veh (s)	0.0	0.1	0.0	0.0
Total Delay (hr)	6.2	0.0	1.1	7.3
Total Del/Veh (s)	99.4	0.2	354.8	76.9
Vehicles Entered	226	107	10	343
Vehicles Exited	215	106	7	328
Hourly Exit Rate	215	106	7	328
Input Volume	249	103	12	364
% of Volume	86	103	58	90

**15: Rue Wellington & rue Centre/Accès Performance by approach**

Approach	EB	WB	NB	SB	All
Denied Delay (hr)	2.4	0.0	0.0	0.0	2.4
Denied Del/Veh (s)	47.0	0.1	0.0	0.1	12.8
Total Delay (hr)	17.3	0.2	9.1	0.2	26.8
Total Del/Veh (s)	341.1	128.2	94.5	5.6	140.7
Vehicles Entered	178	5	343	153	679
Vehicles Exited	157	5	331	153	646
Hourly Exit Rate	157	5	331	153	646
Input Volume	215	4	348	153	720
% of Volume	73	125	95	100	90

16: Shearer & Richardson Performance by approach

Approach	WB	NB	SB	All
Denied Delay (hr)	0.0	0.0	0.0	0.0
Denied Del/Veh (s)	0.0	0.0	0.0	0.0
Total Delay (hr)	0.1	0.0	0.0	0.1
Total Del/Veh (s)	3.1	1.0	0.7	1.4
Vehicles Entered	67	49	116	232
Vehicles Exited	67	49	116	232
Hourly Exit Rate	67	49	116	232
Input Volume	66	47	123	236
% of Volume	102	104	94	98

17: rue Sucrierie & Richardson Performance by approach

Approach	WB	NB	SB	All
Denied Delay (hr)	0.0	0.0	0.0	0.0
Denied Del/Veh (s)	0.1	0.0	0.0	0.0
Total Delay (hr)	0.1	0.0	0.0	0.1
Total Del/Veh (s)	3.7	4.6	3.8	4.0
Vehicles Entered	63	30	5	98
Vehicles Exited	62	30	5	97
Hourly Exit Rate	62	30	5	97
Input Volume	59	35	3	97
% of Volume	105	86	167	100

18: Richardson & Montmorency Performance by approach

Approach	WB	NB	SB	All
Denied Delay (hr)	0.0	0.0	0.0	0.0
Denied Del/Veh (s)	0.1	0.0	0.0	0.0
Total Delay (hr)	0.0	0.0	0.0	0.1
Total Del/Veh (s)	4.4	3.7	0.6	2.0
Vehicles Entered	21	27	73	121
Vehicles Exited	21	27	73	121
Hourly Exit Rate	21	27	73	121
Input Volume	21	27	77	125
% of Volume	100	100	95	97

## 19: rue de la Prairie &amp; Rue Centre Performance by approach

Approach	EB	WB	All
Denied Delay (hr)	0.0	0.0	0.0
Denied Del/Veh (s)	0.0	0.1	0.0
Total Delay (hr)	0.5	0.2	0.6
Total Del/Veh (s)	7.0	6.9	7.0
Vehicles Entered	239	93	332
Vehicles Exited	240	93	333
Hourly Exit Rate	240	93	333
Input Volume	233	99	332
% of Volume	103	94	100

## 20: Rue Bridge &amp; Rue Wellington Performance by approach

Approach	EB	NB	SB	All
Denied Delay (hr)	27.8	0.0	0.0	27.8
Denied Del/Veh (s)	179.3	0.1	0.0	42.2
Total Delay (hr)	26.4	4.8	10.9	42.1
Total Del/Veh (s)	183.3	53.0	26.0	64.3
Vehicles Entered	498	318	1497	2313
Vehicles Exited	485	319	1493	2297
Hourly Exit Rate	485	319	1493	2297
Input Volume	627	319	1619	2565
% of Volume	77	100	92	90

## 21: Rue Ropery &amp; Rue Centre Performance by approach

Approach	EB	WB	All
Denied Delay (hr)	0.0	0.0	0.0
Denied Del/Veh (s)	0.0	0.0	0.0
Total Delay (hr)	0.6	0.4	1.0
Total Del/Veh (s)	8.1	15.2	10.1
Vehicles Entered	244	93	337
Vehicles Exited	245	94	339
Hourly Exit Rate	245	94	339
Input Volume	238	99	337
% of Volume	103	95	101

**23: Rue Island & Rue Centre Performance by approach**

Approach	EB	WB	NB	All
Denied Delay (hr)	0.0	0.0	0.0	0.0
Denied Del/Veh (s)	0.0	0.0	0.1	0.0
Total Delay (hr)	1.1	0.3	0.2	1.6
Total Del/Veh (s)	17.5	14.5	12.9	16.2
Vehicles Entered	228	73	48	349
Vehicles Exited	228	74	48	350
Hourly Exit Rate	228	74	48	350
Input Volume	222	82	49	353
% of Volume	103	90	98	99

**40: Performance by approach**

Approach	NB	All
Denied Delay (hr)	0.0	0.0
Denied Del/Veh (s)	0.0	0.0
Total Delay (hr)	0.0	0.0
Total Del/Veh (s)	0.9	0.9
Vehicles Entered	49	49
Vehicles Exited	49	49
Hourly Exit Rate	49	49
Input Volume	49	49
% of Volume	100	100

**45: St-Patrick/Rue Saint-Patrick Performance by approach**

Approach	EB	WB	NB	SB	All
Denied Delay (hr)	3.8	0.0	0.0	0.0	3.8
Denied Del/Veh (s)	28.7	0.0	2.1	0.1	15.2
Total Delay (hr)	7.6	1.3	0.2	0.0	9.0
Total Del/Veh (s)	58.4	12.4	9.2	13.3	36.0
Vehicles Entered	464	363	62	9	898
Vehicles Exited	452	362	62	9	885
Hourly Exit Rate	452	362	62	9	885
Input Volume	484	353	64	8	909
% of Volume	93	103	97	112	97

---

**Total Network Performance**

---

Denied Delay (hr)	101.0
Denied Del/Veh (s)	70.1
Total Delay (hr)	215.0
Total Del/Veh (s)	148.2
Vehicles Entered	4957
Vehicles Exited	4797
Hourly Exit Rate	4797
Input Volume	23671
% of Volume	20

**Intersection: 1: rue St-Patrick & rue Charlevoix**

Movement	EB	EB	WB	WB	NB	NB	SB	SB
Directions Served	LT	R	LT	R	LT	R	LT	R
Maximum Queue (m)	158.7	37.5	54.0	36.4	137.2	14.5	74.2	16.8
Average Queue (m)	75.3	12.8	18.5	12.0	67.0	6.5	27.2	12.1
95th Queue (m)	132.9	39.1	38.6	27.4	127.2	16.5	53.9	18.8
Link Distance (m)	696.8		363.6		210.6		891.2	
Upstream Blk Time (%)					0			
Queuing Penalty (veh)					0			
Storage Bay Dist (m)		30.0		30.0		7.0		7.0
Storage Blk Time (%)	38	0	2	0	66	7	43	22
Queuing Penalty (veh)	12	1	2	0	16	27	31	34

**Intersection: 2: des Seigneurs & St-Patrick**

Movement	EB	EB	WB	WB	SB	SB
Directions Served	LT	TR	LT	R	LT	R
Maximum Queue (m)	161.7	67.5	65.0	40.0	206.4	17.5
Average Queue (m)	111.3	44.1	36.1	16.5	100.8	12.7
95th Queue (m)	196.7	93.3	61.6	32.6	200.2	23.0
Link Distance (m)	158.0		57.0	57.0	293.6	
Upstream Blk Time (%)	20		3			
Queuing Penalty (veh)	105		4			
Storage Bay Dist (m)		60.0				10.0
Storage Blk Time (%)	52	4			64	3
Queuing Penalty (veh)	109	12			68	11

**Intersection: 3: Shearer/accès & St-Patrick**

Movement	EB	EB	WB	NB	NB
Directions Served	LT	R	LTR	LT	R
Maximum Queue (m)	63.0	11.8	51.3	76.1	22.0
Average Queue (m)	48.9	0.6	8.7	19.5	12.0
95th Queue (m)	82.8	4.8	30.3	62.9	24.1
Link Distance (m)	57.0	57.0	140.3	164.0	
Upstream Blk Time (%)	18				
Queuing Penalty (veh)	66				
Storage Bay Dist (m)					15.0
Storage Blk Time (%)				8	17
Queuing Penalty (veh)				4	9

**Intersection: 4: St-Patrick**

Movement	EB	WB	NB
Directions Served	TR	LT	LR
Maximum Queue (m)	146.4	58.7	47.7
Average Queue (m)	130.0	6.4	17.6
95th Queue (m)	190.1	31.8	45.4
Link Distance (m)	140.3	93.8	72.2
Upstream Blk Time (%)	28	0	2
Queuing Penalty (veh)	206	0	0
Storage Bay Dist (m)			
Storage Blk Time (%)			
Queuing Penalty (veh)			

**Intersection: 5: Montmorency & St-Patrick**

Movement	EB	EB	WB	NB	SB
Directions Served	T	R	LTR	LTR	LTR
Maximum Queue (m)	99.0	22.5	82.0	25.6	13.6
Average Queue (m)	96.4	3.5	41.5	9.7	2.8
95th Queue (m)	102.8	16.3	71.4	21.1	9.3
Link Distance (m)	93.8		195.1	54.9	54.7
Upstream Blk Time (%)	44				
Queuing Penalty (veh)	342				
Storage Bay Dist (m)		15.0			
Storage Blk Time (%)	65	0	51	27	9
Queuing Penalty (veh)	18	2	1	5	0

**Intersection: 6: Rue Bridge & Rue Saint-Patrick**

Movement	EB	WB	WB	NB
Directions Served	R	L	LT	L
Maximum Queue (m)	201.4	94.2	100.0	38.9
Average Queue (m)	197.5	64.9	70.6	13.8
95th Queue (m)	204.8	89.7	96.6	33.0
Link Distance (m)	195.1	258.4	258.4	165.7
Upstream Blk Time (%)	18			
Queuing Penalty (veh)	159			
Storage Bay Dist (m)				
Storage Blk Time (%)				
Queuing Penalty (veh)				



**Intersection: 7: Rue Wellington & Rue Saint-Patrick**

Movement	SB
Directions Served	R
Maximum Queue (m)	86.9
Average Queue (m)	8.7
95th Queue (m)	47.3
Link Distance (m)	252.0
Upstream Blk Time (%)	
Queuing Penalty (veh)	
Storage Bay Dist (m)	
Storage Blk Time (%)	
Queuing Penalty (veh)	

**Intersection: 8: rue Charlevoix & Rue Centre**

Movement	EB	WB	NB	SB
Directions Served	LTR	LTR	LTR	LTR
Maximum Queue (m)	67.8	38.8	50.4	40.9
Average Queue (m)	37.2	16.7	26.2	14.9
95th Queue (m)	58.3	31.2	44.0	31.7
Link Distance (m)	663.3	216.8	401.7	210.6
Upstream Blk Time (%)				
Queuing Penalty (veh)				
Storage Bay Dist (m)				
Storage Blk Time (%)	47	28		
Queuing Penalty (veh)	8	6		

**Intersection: 9: rue Sucrierie**

Movement	EB	NB	SB
Directions Served	LR	LT	TR
Maximum Queue (m)	9.1	7.3	1.4
Average Queue (m)	4.3	0.6	0.0
95th Queue (m)	11.6	4.5	1.0
Link Distance (m)	56.5	82.8	72.2
Upstream Blk Time (%)			
Queuing Penalty (veh)			
Storage Bay Dist (m)			
Storage Blk Time (%)			
Queuing Penalty (veh)			

Intersection: 10: Montmorency

Movement

Directions Served  
 Maximum Queue (m)  
 Average Queue (m)  
 95th Queue (m)  
 Link Distance (m)  
 Upstream Blk Time (%)  
 Queuing Penalty (veh)  
 Storage Bay Dist (m)  
 Storage Blk Time (%)  
 Queuing Penalty (veh)

Intersection: 11: Montmorency

Movement

Directions Served  
 Maximum Queue (m)  
 Average Queue (m)  
 95th Queue (m)  
 Link Distance (m)  
 Upstream Blk Time (%)  
 Queuing Penalty (veh)  
 Storage Bay Dist (m)  
 Storage Blk Time (%)  
 Queuing Penalty (veh)

Intersection: 12: Shearer & Centre

Movement	EB	EB	WB	WB	NB	SB
Directions Served	LT	R	LT	R	LTR	LTR
Maximum Queue (m)	66.0	15.1	22.5	4.9	23.0	56.9
Average Queue (m)	13.1	2.1	4.0	0.3	7.8	25.8
95th Queue (m)	57.2	10.2	13.7	2.6	18.5	55.5
Link Distance (m)	230.7		135.5		152.2	73.3
Upstream Blk Time (%)						3
Queuing Penalty (veh)						1
Storage Bay Dist (m)		15.0		15.0		
Storage Blk Time (%)	12	0	1		17	49
Queuing Penalty (veh)	2	0	0		1	4

**Intersection: 13: rue Sucrierie & Centre**

Movement	EB	WB	WB	NB	SB
Directions Served	LTR	LT	R	LTR	LTR
Maximum Queue (m)	134.5	18.7	5.7	22.4	36.5
Average Queue (m)	56.1	5.8	0.5	6.6	13.7
95th Queue (m)	137.7	15.1	3.3	18.1	32.8
Link Distance (m)	135.5	98.8		155.7	72.4
Upstream Blk Time (%)	14				
Queuing Penalty (veh)	27				
Storage Bay Dist (m)			15.0		
Storage Blk Time (%)	57	2		22	36
Queuing Penalty (veh)	5	0		3	2

**Intersection: 14: rue Centre/Centre**

Movement	EB	SB
Directions Served	LT	LR
Maximum Queue (m)	102.0	26.8
Average Queue (m)	47.9	8.8
95th Queue (m)	125.9	31.9
Link Distance (m)	98.8	72.2
Upstream Blk Time (%)	29	
Queuing Penalty (veh)	73	
Storage Bay Dist (m)		
Storage Blk Time (%)		
Queuing Penalty (veh)		

**Intersection: 15: Rue Wellington & rue Centre/accès**

Movement	EB	WB	NB	NB	B37	SB	SB
Directions Served	LTR	LTR	LT	TR	T	LT	TR
Maximum Queue (m)	169.6	23.2	92.8	94.4	147.4	30.6	14.7
Average Queue (m)	129.9	4.3	48.5	63.0	27.3	10.3	2.7
95th Queue (m)	215.4	16.7	102.4	110.8	100.1	24.8	10.3
Link Distance (m)	165.7	202.1	75.8	75.8	296.5	172.8	172.8
Upstream Blk Time (%)	45		13	26			
Queuing Penalty (veh)	92		0	0			
Storage Bay Dist (m)							
Storage Blk Time (%)							
Queuing Penalty (veh)							

**Intersection: 16: Shearer & Richardson**

Movement	WB	NB	SB
Directions Served	LTR	T	TR
Maximum Queue (m)	11.9	3.6	4.3
Average Queue (m)	6.6	0.1	0.2
95th Queue (m)	13.3	1.9	3.5
Link Distance (m)	145.1	73.3	164.0
Upstream Blk Time (%)			
Queuing Penalty (veh)			
Storage Bay Dist (m)			
Storage Blk Time (%)			
Queuing Penalty (veh)			

**Intersection: 17: rue Sucrierie & Richardson**

Movement	WB	NB	SB
Directions Served	LTR	LT	TR
Maximum Queue (m)	16.7	9.1	9.2
Average Queue (m)	8.6	5.7	1.3
95th Queue (m)	14.2	12.7	6.5
Link Distance (m)	95.4	72.4	82.8
Upstream Blk Time (%)			
Queuing Penalty (veh)			
Storage Bay Dist (m)			
Storage Blk Time (%)			
Queuing Penalty (veh)			

**Intersection: 18: Richardson & Montmorency**

Movement	WB	NB	SB
Directions Served	LTR	LT	TR
Maximum Queue (m)	12.2	9.2	9.2
Average Queue (m)	4.6	5.2	2.5
95th Queue (m)	12.6	12.6	9.2
Link Distance (m)	197.3	72.2	35.2
Upstream Blk Time (%)			
Queuing Penalty (veh)			
Storage Bay Dist (m)			
Storage Blk Time (%)			
Queuing Penalty (veh)			

Intersection: 19: rue de la Prairie & Rue Centre

Movement	EB	WB
Directions Served	LTR	LTR
Maximum Queue (m)	29.9	18.4
Average Queue (m)	13.1	7.3
95th Queue (m)	25.3	16.9
Link Distance (m)	127.6	127.0
Upstream Blk Time (%)		
Queuing Penalty (veh)		
Storage Bay Dist (m)		
Storage Blk Time (%)		
Queuing Penalty (veh)		

Intersection: 20: Rue Bridge & Rue Wellington

Movement	EB	EB	NB	NB	NB	SB	SB	SB
Directions Served	T	TR	LT	TR	R	LT	T	R
Maximum Queue (m)	185.7	181.6	41.2	44.4	33.1	159.6	158.4	8.7
Average Queue (m)	114.4	171.1	25.5	25.5	12.6	80.7	84.3	4.0
95th Queue (m)	222.7	196.8	38.5	38.9	25.6	146.4	149.6	10.2
Link Distance (m)	172.8	172.8	694.3	694.3		165.7	165.7	
Upstream Blk Time (%)	12	59				0	1	
Queuing Penalty (veh)	34	164				3	5	
Storage Bay Dist (m)					60.0			0.1
Storage Blk Time (%)		81					47	3
Queuing Penalty (veh)		154					13	17

Intersection: 21: Rue Ropery & Rue Centre

Movement	EB	WB
Directions Served	LT	LT
Maximum Queue (m)	34.1	31.9
Average Queue (m)	14.1	14.1
95th Queue (m)	27.1	26.6
Link Distance (m)	216.8	127.6
Upstream Blk Time (%)		
Queuing Penalty (veh)		
Storage Bay Dist (m)		
Storage Blk Time (%)	12	1
Queuing Penalty (veh)	0	0

**Intersection: 23: Rue Island & Rue Centre**

Movement	EB	WB	NB
Directions Served	LT	TR	LTR
Maximum Queue (m)	48.2	29.8	22.9
Average Queue (m)	24.8	9.0	7.6
95th Queue (m)	41.5	20.8	18.3
Link Distance (m)	127.0	230.7	153.9
Upstream Blk Time (%)			
Queuing Penalty (veh)			
Storage Bay Dist (m)			
Storage Blk Time (%)			13
Queuing Penalty (veh)			1

**Intersection: 40:**

Movement
Directions Served
Maximum Queue (m)
Average Queue (m)
95th Queue (m)
Link Distance (m)
Upstream Blk Time (%)
Queuing Penalty (veh)
Storage Bay Dist (m)
Storage Blk Time (%)
Queuing Penalty (veh)

**Intersection: 45: St-Patrick/Rue Saint-Patrick**

Movement	EB	B39	WB	NB	NB	SB	SB
Directions Served	LT	T	TR	LT	R	L	R
Maximum Queue (m)	121.8	76.7	55.5	20.4	15.0	8.9	8.9
Average Queue (m)	69.0	8.7	24.3	6.5	7.1	1.7	1.1
95th Queue (m)	170.4	61.9	44.5	15.4	16.7	7.4	5.8
Link Distance (m)	157.6	363.6	158.0			57.1	57.1
Upstream Blk Time (%)	10						
Queuing Penalty (veh)	42						
Storage Bay Dist (m)					10.0		
Storage Blk Time (%)				3	8		
Queuing Penalty (veh)				1	3		

**Network Summary**

Network wide Queuing Penalty: 1902
------------------------------------

**1: rue St-Patrick & rue Charlevoix Performance by approach**

Approach	EB	WB	NB	SB	All
Denied Delay (hr)	0.1	0.0	0.0	0.0	0.1
Denied Del/Veh (s)	0.4	0.0	0.2	0.2	0.2
Total Delay (hr)	5.3	0.9	4.5	1.5	12.2
Total Del/Veh (s)	32.1	8.4	41.9	23.2	27.4
Vehicles Entered	575	392	382	229	1578
Vehicles Exited	580	391	373	225	1569
Hourly Exit Rate	580	391	373	225	1569
Input Volume	584	389	383	223	1579
% of Volume	99	101	97	101	99

**2: des Seigneurs & St-Patrick Performance by approach**

Approach	EB	WB	SB	All
Denied Delay (hr)	0.0	0.0	0.2	0.2
Denied Del/Veh (s)	0.0	0.3	1.3	0.5
Total Delay (hr)	4.8	2.0	3.5	10.3
Total Del/Veh (s)	33.0	19.1	27.1	27.2
Vehicles Entered	521	375	455	1351
Vehicles Exited	521	374	454	1349
Hourly Exit Rate	521	374	454	1349
Input Volume	522	378	454	1354
% of Volume	100	99	100	100

**3: Shearer/Accès & St-Patrick Performance by approach**

Approach	EB	WB	NB	All
Denied Delay (hr)	0.0	0.0	0.0	0.1
Denied Del/Veh (s)	0.2	0.1	0.6	0.2
Total Delay (hr)	0.3	0.3	0.4	1.0
Total Del/Veh (s)	1.4	3.2	13.1	2.8
Vehicles Entered	836	329	97	1262
Vehicles Exited	835	327	98	1260
Hourly Exit Rate	835	327	98	1260
Input Volume	835	329	101	1265
% of Volume	100	99	97	100

---

**4: St-Patrick Performance by approach**

---

Approach	EB	WB	NB	All
Denied Delay (hr)	0.0	0.0	0.0	0.0
Denied Del/Veh (s)	0.0	0.1	0.0	0.0
Total Delay (hr)	0.3	0.2	0.0	0.5
Total Del/Veh (s)	1.2	2.8	8.7	1.8
Vehicles Entered	730	313	18	1061
Vehicles Exited	731	312	19	1062
Hourly Exit Rate	731	312	19	1062
Input Volume	727	309	19	1055
% of Volume	101	101	100	101

---

**5: Montmorency & St-Patrick Performance by approach**

---

Approach	EB	WB	NB	SB	All
Denied Delay (hr)	0.1	0.0	0.0	0.0	0.1
Denied Del/Veh (s)	0.5	0.0	0.1	0.1	0.3
Total Delay (hr)	2.7	1.9	0.3	0.1	5.0
Total Del/Veh (s)	14.8	18.4	21.2	25.7	16.4
Vehicles Entered	654	371	53	13	1091
Vehicles Exited	652	371	51	13	1087
Hourly Exit Rate	652	371	51	13	1087
Input Volume	656	361	62	12	1091
% of Volume	99	103	82	108	100

---

**6: Rue Bridge & Rue Saint-Patrick Performance by approach**

---

Approach	EB	WB	NB	All
Denied Delay (hr)	0.0	0.0	0.0	0.0
Denied Del/Veh (s)	0.0	0.0	0.0	0.0
Total Delay (hr)	6.8	8.1	1.1	16.0
Total Del/Veh (s)	36.0	25.5	17.0	28.0
Vehicles Entered	666	1124	239	2029
Vehicles Exited	666	1130	240	2036
Hourly Exit Rate	666	1130	240	2036
Input Volume	676	1111	239	2026
% of Volume	99	102	100	100



---

**7: Rue Wellington & Rue Saint-Patrick Performance by approach**

---

Approach	NB	SB	All
Denied Delay (hr)	0.0	0.5	0.5
Denied Del/Veh (s)	0.0	1.6	1.1
Total Delay (hr)	0.1	3.0	3.1
Total Del/Veh (s)	1.1	9.5	7.0
Vehicles Entered	462	1119	1581
Vehicles Exited	461	1119	1580
Hourly Exit Rate	461	1119	1580
Input Volume	492	1107	1599
% of Volume	94	101	99

---

**8: rue Charlevoix & Rue Centre Performance by approach**

---

Approach	EB	WB	NB	SB	All
Denied Delay (hr)	0.0	0.0	0.0	0.0	0.0
Denied Del/Veh (s)	0.3	0.0	0.2	0.0	0.2
Total Delay (hr)	1.8	0.5	1.1	0.5	3.9
Total Del/Veh (s)	18.9	20.5	14.4	12.3	16.5
Vehicles Entered	327	90	263	152	832
Vehicles Exited	327	89	264	151	831
Hourly Exit Rate	327	89	264	151	831
Input Volume	333	99	256	150	838
% of Volume	98	90	103	101	99

---

**9: rue Sucrierie Performance by approach**

---

Approach	EB	NB	SB	All
Denied Delay (hr)	0.0	0.0	0.0	0.0
Denied Del/Veh (s)	0.1	0.0	0.0	0.0
Total Delay (hr)	0.0	0.0	0.0	0.1
Total Del/Veh (s)	3.9	3.0	0.4	1.8
Vehicles Entered	21	27	54	102
Vehicles Exited	20	27	54	101
Hourly Exit Rate	20	27	54	101
Input Volume	21	27	48	96
% of Volume	95	100	112	105

---

**10: Montmorency Performance by approach**

---

Approach	NB	SB	All
Denied Delay (hr)	0.0	0.0	0.0
Denied Del/Veh (s)	0.0	0.0	0.0
Total Delay (hr)	0.0	0.0	0.0
Total Del/Veh (s)	0.0	0.6	0.5
Vehicles Entered	11	85	96
Vehicles Exited	11	84	95
Hourly Exit Rate	11	84	95
Input Volume	12	86	98
% of Volume	92	98	97

---

**11: Montmorency Performance by approach**

---

Approach	NB	SB	All
Denied Delay (hr)	0.0	0.0	0.0
Denied Del/Veh (s)	0.0	0.0	0.0
Total Delay (hr)	0.0	0.0	0.0
Total Del/Veh (s)	1.0	0.0	0.1
Vehicles Entered	11	84	95
Vehicles Exited	11	85	96
Hourly Exit Rate	11	85	96
Input Volume	12	86	98
% of Volume	92	99	98

---

**12: Shearer & Centre Performance by approach**

---

Approach	EB	WB	NB	SB	All
Denied Delay (hr)	0.0	0.0	0.0	0.0	0.0
Denied Del/Veh (s)	0.0	0.0	0.1	0.3	0.1
Total Delay (hr)	0.3	0.1	0.2	0.8	1.4
Total Del/Veh (s)	4.9	6.5	12.6	17.0	10.2
Vehicles Entered	209	59	45	178	491
Vehicles Exited	209	59	45	179	492
Hourly Exit Rate	209	59	45	179	492
Input Volume	210	60	47	178	495
% of Volume	100	98	96	101	99

**13: rue Sucrierie & Centre Performance by approach**

Approach	EB	WB	NB	SB	All
Denied Delay (hr)	0.0	0.0	0.0	0.0	0.0
Denied Del/Veh (s)	0.0	0.0	0.1	0.1	0.0
Total Delay (hr)	0.8	0.1	0.2	0.3	1.4
Total Del/Veh (s)	13.8	5.5	13.4	14.6	12.1
Vehicles Entered	203	86	41	74	404
Vehicles Exited	202	86	41	74	403
Hourly Exit Rate	202	86	41	74	403
Input Volume	201	90	42	78	411
% of Volume	100	96	98	95	98

**14: rue Centre/Centre Performance by approach**

Approach	EB	WB	SB	All
Denied Delay (hr)	0.0	0.0	0.0	0.0
Denied Del/Veh (s)	0.0	0.1	0.0	0.0
Total Delay (hr)	0.1	0.0	0.0	0.1
Total Del/Veh (s)	1.5	0.3	5.1	1.2
Vehicles Entered	251	97	10	358
Vehicles Exited	251	97	10	358
Hourly Exit Rate	251	97	10	358
Input Volume	249	103	12	364
% of Volume	101	94	83	98

**15: Rue Wellington & rue Centre/Accès Performance by approach**

Approach	EB	WB	NB	SB	All
Denied Delay (hr)	6.1	0.0	0.0	0.0	6.1
Denied Del/Veh (s)	99.2	0.1	0.0	0.1	28.9
Total Delay (hr)	7.7	0.1	5.8	0.2	13.8
Total Del/Veh (s)	139.6	48.1	56.0	5.0	67.6
Vehicles Entered	195	4	375	156	730
Vehicles Exited	186	4	366	155	711
Hourly Exit Rate	186	4	366	155	711
Input Volume	224	4	368	158	754
% of Volume	83	100	99	98	94

---

**16: Shearer & Richardson Performance by approach**

---

Approach	WB	NB	SB	All
Denied Delay (hr)	0.0	0.0	0.0	0.0
Denied Del/Veh (s)	0.0	0.0	0.0	0.0
Total Delay (hr)	0.1	0.0	0.0	0.1
Total Del/Veh (s)	3.3	0.9	0.3	1.3
Vehicles Entered	66	43	121	230
Vehicles Exited	66	43	121	230
Hourly Exit Rate	66	43	121	230
Input Volume	66	47	123	236
% of Volume	100	91	98	97

---

**17: rue Sucrierie & Richardson Performance by approach**

---

Approach	WB	NB	SB	All
Denied Delay (hr)	0.0	0.0	0.0	0.0
Denied Del/Veh (s)	0.1	0.0	0.0	0.0
Total Delay (hr)	0.1	0.0	0.0	0.1
Total Del/Veh (s)	3.7	4.7	2.9	4.0
Vehicles Entered	62	33	4	99
Vehicles Exited	62	33	4	99
Hourly Exit Rate	62	33	4	99
Input Volume	59	35	3	97
% of Volume	105	94	133	102

---

**18: Richardson & Montmorency Performance by approach**

---

Approach	WB	NB	SB	All
Denied Delay (hr)	0.0	0.0	0.0	0.0
Denied Del/Veh (s)	0.1	0.0	0.0	0.0
Total Delay (hr)	0.0	0.0	0.0	0.1
Total Del/Veh (s)	4.4	3.5	0.4	1.8
Vehicles Entered	21	26	75	122
Vehicles Exited	21	27	75	123
Hourly Exit Rate	21	27	75	123
Input Volume	21	27	77	125
% of Volume	100	100	97	98

19: rue de la Prairie & Rue Centre Performance by approach

Approach	EB	WB	All
Denied Delay (hr)	0.0	0.0	0.0
Denied Del/Veh (s)	0.0	0.1	0.0
Total Delay (hr)	0.4	0.2	0.6
Total Del/Veh (s)	6.3	6.8	6.4
Vehicles Entered	233	90	323
Vehicles Exited	232	90	322
Hourly Exit Rate	232	90	322
Input Volume	233	99	332
% of Volume	100	91	97

20: Rue Bridge & Rue Wellington Performance by approach

Approach	EB	NB	SB	All
Denied Delay (hr)	0.0	0.0	0.0	0.0
Denied Del/Veh (s)	0.0	0.1	0.1	0.1
Total Delay (hr)	31.0	4.7	11.8	47.5
Total Del/Veh (s)	195.9	51.7	30.2	74.2
Vehicles Entered	549	317	1389	2255
Vehicles Exited	527	317	1394	2238
Hourly Exit Rate	527	317	1394	2238
Input Volume	589	319	1396	2304
% of Volume	89	99	100	97

21: Rue Ropery & Rue Centre Performance by approach

Approach	EB	WB	All
Denied Delay (hr)	0.0	0.0	0.0
Denied Del/Veh (s)	0.0	0.0	0.0
Total Delay (hr)	0.6	0.4	1.0
Total Del/Veh (s)	8.4	16.2	10.5
Vehicles Entered	238	90	328
Vehicles Exited	239	91	330
Hourly Exit Rate	239	91	330
Input Volume	238	99	337
% of Volume	100	92	98

**23: Rue Island & Rue Centre Performance by approach**

Approach	EB	WB	NB	All
Denied Delay (hr)	0.0	0.0	0.0	0.0
Denied Del/Veh (s)	0.0	0.0	0.1	0.0
Total Delay (hr)	1.1	0.3	0.2	1.6
Total Del/Veh (s)	18.0	16.0	11.3	16.6
Vehicles Entered	217	75	50	342
Vehicles Exited	218	75	50	343
Hourly Exit Rate	218	75	50	343
Input Volume	222	82	49	353
% of Volume	98	91	102	97

**40: Performance by approach**

Approach	NB	All
Denied Delay (hr)	0.0	0.0
Denied Del/Veh (s)	0.0	0.0
Total Delay (hr)	0.0	0.0
Total Del/Veh (s)	0.9	0.9
Vehicles Entered	50	50
Vehicles Exited	50	50
Hourly Exit Rate	50	50
Input Volume	49	49
% of Volume	102	102

**45: St-Patrick/Rue Saint-Patrick Performance by approach**

Approach	EB	WB	NB	SB	All
Denied Delay (hr)	0.0	0.0	0.0	0.0	0.1
Denied Del/Veh (s)	0.1	0.0	2.1	0.1	0.2
Total Delay (hr)	1.6	1.1	0.1	0.0	2.8
Total Del/Veh (s)	11.9	10.9	4.9	4.0	11.0
Vehicles Entered	481	358	62	7	908
Vehicles Exited	483	358	62	7	910
Hourly Exit Rate	483	358	62	7	910
Input Volume	484	353	64	8	909
% of Volume	100	101	97	88	100

---

Total Network Performance

---

Denied Delay (hr)	7.2
Denied Del/Veh (s)	5.2
Total Delay (hr)	127.9
Total Del/Veh (s)	87.6
Vehicles Entered	5036
Vehicles Exited	4974
Hourly Exit Rate	4974
Input Volume	22741
% of Volume	22

Intersection: 1: rue St-Patrick & rue Charlevoix

Movement	EB	EB	WB	WB	NB	NB	SB	SB
Directions Served	LT	R	LT	R	LT	R	LT	R
Maximum Queue (m)	161.9	37.5	48.4	36.4	147.1	14.5	49.6	18.8
Average Queue (m)	72.2	9.5	17.5	11.9	63.1	7.2	24.8	11.6
95th Queue (m)	135.8	32.5	34.9	28.2	114.8	17.8	44.8	19.6
Link Distance (m)	696.8		363.6		210.6		891.2	
Upstream Blk Time (%)					0			
Queuing Penalty (veh)					0			
Storage Bay Dist (m)		30.0		30.0		7.0		7.0
Storage Blk Time (%)	37	0	2	0	65	7	41	24
Queuing Penalty (veh)	12	0	2	1	16	26	30	36

Intersection: 2: des Seigneurs & St-Patrick

Movement	EB	EB	WB	WB	SB	SB
Directions Served	LT	TR	LT	R	LT	R
Maximum Queue (m)	126.9	66.9	61.6	34.1	97.4	17.5
Average Queue (m)	59.3	20.6	30.2	15.5	54.7	13.0
95th Queue (m)	113.5	62.2	54.2	29.3	88.0	23.1
Link Distance (m)	158.0		57.0	57.0	293.6	
Upstream Blk Time (%)	1		1			
Queuing Penalty (veh)	4		2			
Storage Bay Dist (m)		60.0				10.0
Storage Blk Time (%)	13	1			48	6
Queuing Penalty (veh)	28	2			51	21

Intersection: 3: Shearer/Accès & St-Patrick

Movement	EB	EB	WB	NB	NB
Directions Served	LT	R	LTR	LT	R
Maximum Queue (m)	23.0	10.8	48.4	29.7	21.3
Average Queue (m)	2.0	0.7	8.1	9.2	7.3
95th Queue (m)	12.1	5.3	27.8	20.7	16.9
Link Distance (m)	57.0	57.0	140.3	164.0	
Upstream Blk Time (%)					
Queuing Penalty (veh)					
Storage Bay Dist (m)					15.0
Storage Blk Time (%)				5	1
Queuing Penalty (veh)				2	0



**Intersection: 4: St-Patrick**

Movement	EB	WB	NB
Directions Served	TR	LT	LR
Maximum Queue (m)	10.8	40.7	11.9
Average Queue (m)	0.8	6.4	4.1
95th Queue (m)	6.4	23.8	11.9
Link Distance (m)	140.3	93.8	72.2
Upstream Blk Time (%)			
Queuing Penalty (veh)			
Storage Bay Dist (m)			
Storage Blk Time (%)			
Queuing Penalty (veh)			

**Intersection: 5: Montmorency & St-Patrick**

Movement	EB	EB	WB	NB	SB
Directions Served	T	R	LTR	LTR	LTR
Maximum Queue (m)	94.9	22.5	79.0	23.9	12.6
Average Queue (m)	58.5	3.8	35.3	7.7	2.9
95th Queue (m)	92.6	15.9	62.2	17.8	9.3
Link Distance (m)	93.8		195.1	54.9	54.7
Upstream Blk Time (%)	1				
Queuing Penalty (veh)	3				
Storage Bay Dist (m)		15.0			
Storage Blk Time (%)	33	0	44	23	8
Queuing Penalty (veh)	9	2	0	4	0

**Intersection: 6: Rue Bridge & Rue Saint-Patrick**

Movement	EB	WB	WB	NB
Directions Served	R	L	LT	L
Maximum Queue (m)	185.5	106.4	111.0	44.2
Average Queue (m)	105.3	67.9	74.4	15.6
95th Queue (m)	165.6	94.2	100.9	36.6
Link Distance (m)	195.1	258.4	258.4	165.7
Upstream Blk Time (%)	0			
Queuing Penalty (veh)	2			
Storage Bay Dist (m)				
Storage Blk Time (%)				
Queuing Penalty (veh)				

Intersection: 7: Rue Wellington & Rue Saint-Patrick

Movement	SB
Directions Served	R
Maximum Queue (m)	116.8
Average Queue (m)	13.9
95th Queue (m)	74.5
Link Distance (m)	252.0
Upstream Blk Time (%)	0
Queuing Penalty (veh)	0
Storage Bay Dist (m)	
Storage Blk Time (%)	
Queuing Penalty (veh)	

Intersection: 8: rue Charlevoix & Rue Centre

Movement	EB	WB	NB	SB
Directions Served	LTR	LTR	LTR	LTR
Maximum Queue (m)	70.3	38.8	58.0	37.4
Average Queue (m)	36.2	16.4	25.9	13.9
95th Queue (m)	60.3	32.0	45.7	28.4
Link Distance (m)	663.3	216.8	401.7	210.6
Upstream Blk Time (%)				
Queuing Penalty (veh)				
Storage Bay Dist (m)				
Storage Blk Time (%)	48	27		
Queuing Penalty (veh)	8	6		

Intersection: 9: rue Sucrierie

Movement	EB	NB
Directions Served	LR	LT
Maximum Queue (m)	10.5	7.3
Average Queue (m)	4.1	0.6
95th Queue (m)	11.5	4.2
Link Distance (m)	56.5	82.8
Upstream Blk Time (%)		
Queuing Penalty (veh)		
Storage Bay Dist (m)		
Storage Blk Time (%)		
Queuing Penalty (veh)		

Intersection: 10: Montmorency

Movement

Directions Served  
 Maximum Queue (m)  
 Average Queue (m)  
 95th Queue (m)  
 Link Distance (m)  
 Upstream Blk Time (%)  
 Queuing Penalty (veh)  
 Storage Bay Dist (m)  
 Storage Blk Time (%)  
 Queuing Penalty (veh)

Intersection: 11: Montmorency

Movement

Directions Served  
 Maximum Queue (m)  
 Average Queue (m)  
 95th Queue (m)  
 Link Distance (m)  
 Upstream Blk Time (%)  
 Queuing Penalty (veh)  
 Storage Bay Dist (m)  
 Storage Blk Time (%)  
 Queuing Penalty (veh)

Intersection: 12: Shearer & Centre

Movement	EB	EB	WB	WB	NB	SB
Directions Served	LT	R	LT	R	LTR	LTR
Maximum Queue (m)	19.8	10.7	16.1	10.1	15.0	44.2
Average Queue (m)	5.1	1.0	3.6	0.7	5.7	21.0
95th Queue (m)	15.0	5.3	11.8	4.8	13.1	36.6
Link Distance (m)	230.7		135.5		152.2	73.3
Upstream Blk Time (%)						
Queuing Penalty (veh)						
Storage Bay Dist (m)		15.0		15.0		
Storage Blk Time (%)	2	0	1	0	13	41
Queuing Penalty (veh)	0	0	0	0	0	4

**Intersection: 13: rue Sucrierie & Centre**

Movement	EB	WB	WB	NB	SB
Directions Served	LTR	LT	R	LTR	LTR
Maximum Queue (m)	45.2	21.4	9.5	19.2	24.0
Average Queue (m)	21.1	6.3	0.8	5.1	9.4
95th Queue (m)	37.8	16.5	5.0	14.4	20.6
Link Distance (m)	135.5	98.8		155.7	72.4
Upstream Blk Time (%)					
Queuing Penalty (veh)					
Storage Bay Dist (m)			15.0		
Storage Blk Time (%)	32	2	0	12	20
Queuing Penalty (veh)	3	0	0	2	1

**Intersection: 14: rue Centre/Centre**

Movement	EB	SB
Directions Served	LT	LR
Maximum Queue (m)	7.6	9.2
Average Queue (m)	0.9	2.5
95th Queue (m)	6.4	9.1
Link Distance (m)	98.8	72.2
Upstream Blk Time (%)		
Queuing Penalty (veh)		
Storage Bay Dist (m)		
Storage Blk Time (%)		
Queuing Penalty (veh)		

**Intersection: 15: Rue Wellington & rue Centre/Accès**

Movement	EB	WB	NB	NB	B37	SB	SB
Directions Served	LTR	LTR	LT	TR	T	LT	TR
Maximum Queue (m)	134.5	19.3	84.3	78.4	87.3	30.2	14.6
Average Queue (m)	74.7	2.5	38.3	37.3	15.0	9.7	2.4
95th Queue (m)	150.8	12.0	89.2	84.4	94.6	24.0	9.8
Link Distance (m)	165.7	202.1	75.8	75.8	296.5	172.8	172.8
Upstream Blk Time (%)	2		8	6	1		
Queuing Penalty (veh)	2		0	0	0		
Storage Bay Dist (m)							
Storage Blk Time (%)							
Queuing Penalty (veh)							

**Intersection: 16: Shearer & Richardson**

Movement	WB	NB	SB
Directions Served	LTR	T	TR
Maximum Queue (m)	10.6	1.9	1.8
Average Queue (m)	6.8	0.1	0.1
95th Queue (m)	13.2	1.4	1.3
Link Distance (m)	145.1	73.3	164.0
Upstream Blk Time (%)			
Queuing Penalty (veh)			
Storage Bay Dist (m)			
Storage Blk Time (%)			
Queuing Penalty (veh)			

**Intersection: 17: rue Sucrierie & Richardson**

Movement	WB	NB	SB
Directions Served	LTR	LT	TR
Maximum Queue (m)	15.3	12.1	9.1
Average Queue (m)	8.5	6.1	1.0
95th Queue (m)	14.5	13.5	5.7
Link Distance (m)	95.4	72.4	82.8
Upstream Blk Time (%)			
Queuing Penalty (veh)			
Storage Bay Dist (m)			
Storage Blk Time (%)			
Queuing Penalty (veh)			

**Intersection: 18: Richardson & Montmorency**

Movement	WB	NB	SB
Directions Served	LTR	LT	TR
Maximum Queue (m)	11.9	10.5	9.2
Average Queue (m)	4.4	4.5	2.0
95th Queue (m)	12.2	12.0	8.2
Link Distance (m)	197.3	72.2	35.2
Upstream Blk Time (%)			
Queuing Penalty (veh)			
Storage Bay Dist (m)			
Storage Blk Time (%)			
Queuing Penalty (veh)			

**Intersection: 19: rue de la Prairie & Rue Centre**

Movement	EB	WB
Directions Served	LTR	LTR
Maximum Queue (m)	30.7	21.0
Average Queue (m)	12.1	6.9
95th Queue (m)	25.1	18.1
Link Distance (m)	127.6	127.0
Upstream Blk Time (%)		
Queuing Penalty (veh)		
Storage Bay Dist (m)		
Storage Blk Time (%)		
Queuing Penalty (veh)		

**Intersection: 20: Rue Bridge & Rue Wellington**

Movement	EB	EB	NB	NB	NB	SB	SB	SB
Directions Served	T	TR	LT	TR	R	LT	T	R
Maximum Queue (m)	178.8	182.6	42.2	44.9	33.0	163.6	167.2	8.7
Average Queue (m)	147.1	156.2	24.6	25.1	12.9	85.4	85.9	3.5
95th Queue (m)	211.1	206.3	39.1	39.9	26.2	154.4	155.4	9.7
Link Distance (m)	172.8	172.8	694.3	694.3		165.7	165.7	
Upstream Blk Time (%)	28	35				1	1	
Queuing Penalty (veh)	83	103				6	8	
Storage Bay Dist (m)					60.0			0.1
Storage Blk Time (%)		81		0			48	2
Queuing Penalty (veh)		132		0			13	12

**Intersection: 21: Rue Ropery & Rue Centre**

Movement	EB	WB
Directions Served	LT	LT
Maximum Queue (m)	33.0	31.0
Average Queue (m)	15.3	15.0
95th Queue (m)	29.8	26.5
Link Distance (m)	216.8	127.6
Upstream Blk Time (%)		
Queuing Penalty (veh)		
Storage Bay Dist (m)		
Storage Blk Time (%)	11	0
Queuing Penalty (veh)	0	0

**Intersection: 23: Rue Island & Rue Centre**

Movement	EB	WB	NB
Directions Served	LT	TR	LTR
Maximum Queue (m)	51.5	27.9	19.7
Average Queue (m)	24.8	10.5	6.9
95th Queue (m)	42.4	21.5	17.1
Link Distance (m)	127.0	230.7	153.9
Upstream Blk Time (%)			
Queuing Penalty (veh)			
Storage Bay Dist (m)			
Storage Blk Time (%)			13
Queuing Penalty (veh)			1

**Intersection: 40:**

Movement
Directions Served
Maximum Queue (m)
Average Queue (m)
95th Queue (m)
Link Distance (m)
Upstream Blk Time (%)
Queuing Penalty (veh)
Storage Bay Dist (m)
Storage Blk Time (%)
Queuing Penalty (veh)

**Intersection: 45: St-Patrick/Rue Saint-Patrick**

Movement	EB	WB	NB	NB	SB	SB
Directions Served	LT	TR	LT	R	L	R
Maximum Queue (m)	66.6	46.7	12.1	12.6	7.1	7.1
Average Queue (m)	24.6	19.7	6.1	7.5	0.8	1.1
95th Queue (m)	48.3	34.8	13.5	16.6	4.8	5.8
Link Distance (m)	157.6	158.0			57.1	57.1
Upstream Blk Time (%)						
Queuing Penalty (veh)						
Storage Bay Dist (m)				10.0		
Storage Blk Time (%)			3	3		
Queuing Penalty (veh)			1	1		

**Network Summary**

Network wide Queuing Penalty: 640

1: rue St-Patrick & rue Charlevoix Performance by movement

Movement	EBL	EBT	EBR	WBL	WBT	WBR	NBL	NBT	NBR	SBL	SBT	SBR
Denied Delay (hr)	0.0	0.0	0.0	0.0	0.0	0.0	0.0	0.0	0.0	0.0	0.0	0.0
Denied Del/Veh (s)	0.4	0.4	1.0	0.0	0.0	0.0	1.3	0.2	0.1	0.2	0.2	0.2
Total Delay (hr)	2.0	3.3	0.3	0.0	0.6	0.3	1.6	3.2	0.3	0.3	0.9	0.5
Total Del/Veh (s)	33.1	33.8	26.0	17.9	7.1	11.0	48.3	47.8	42.7	28.3	26.9	24.2
Vehicles Entered	208	342	36	5	293	98	120	240	24	40	114	76
Vehicles Exited	209	345	36	5	294	99	118	235	24	41	114	73
Hourly Exit Rate	209	345	36	5	294	99	118	235	24	41	114	73
Input Volume	206	346	32	5	283	101	115	244	24	37	113	73
% of Volume	101	100	112	100	104	98	103	96	100	111	101	100

1: rue St-Patrick & rue Charlevoix Performance by movement

Movement	All
Denied Delay (hr)	0.1
Denied Del/Veh (s)	0.3
Total Delay (hr)	13.3
Total Del/Veh (s)	29.4
Vehicles Entered	1596
Vehicles Exited	1593
Hourly Exit Rate	1593
Input Volume	1579
% of Volume	101

2: des Seigneurs & St-Patrick Performance by movement

Movement	EBL	EBT	EBR	WBL	WBT	WBR	SBL	SBT	SBR	All
Denied Delay (hr)	0.1	0.3	0.0	0.0	0.0	0.0	0.1	0.0	0.1	0.6
Denied Del/Veh (s)	2.5	3.1	0.2	1.2	0.6	0.2	0.6	0.8	3.5	1.6
Total Delay (hr)	2.9	10.0	0.1	0.0	1.9	0.7	7.2	0.1	1.8	24.8
Total Del/Veh (s)	98.3	94.0	68.6	25.7	24.5	23.0	76.2	93.9	61.7	66.6
Vehicles Entered	105	377	5	5	273	114	331	5	103	1318
Vehicles Exited	102	365	5	5	275	114	327	5	101	1299
Hourly Exit Rate	102	365	5	5	275	114	327	5	101	1299
Input Volume	107	411	4	7	256	115	343	5	106	1354
% of Volume	95	89	125	71	107	99	95	100	95	96



3: Shearer/Accès & St-Patrick Performance by movement

Movement	EBL	EBT	EBR	WBL	WBT	NBL	NBR	All
Denied Delay (hr)	0.0	1.4	0.0	0.0	0.0	0.0	0.0	1.5
Denied Del/Veh (s)		7.4	1.8	0.1	0.1	1.8	2.7	4.5
Total Delay (hr)	0.0	3.4	0.0	0.1	0.3	0.6	1.2	5.5
Total Del/Veh (s)		17.6	1.0	9.1	3.1	40.1	73.7	16.2
Vehicles Entered	0	684	84	32	304	54	56	1214
Vehicles Exited	0	679	84	32	304	53	53	1205
Hourly Exit Rate	0	679	84	32	304	53	53	1205
Input Volume	1	746	88	35	294	51	50	1265
% of Volume	0	91	95	91	103	104	106	95

4: St-Patrick Performance by movement

Movement	EBT	EBR	WBL	WBT	NBL	NBR	All
Denied Delay (hr)	17.1	0.3	0.0	0.0	0.0	0.0	17.4
Denied Del/Veh (s)	77.7	77.7	0.0	0.1	0.0	0.0	55.3
Total Delay (hr)	13.1	0.2	0.1	0.3	0.8	1.6	16.1
Total Del/Veh (s)	62.3	63.1	10.7	3.7	391.7	645.4	52.6
Vehicles Entered	750	14	19	294	7	8	1092
Vehicles Exited	743	14	19	293	5	5	1079
Hourly Exit Rate	743	14	19	293	5	5	1079
Input Volume	853	17	21	288	10	9	1198
% of Volume	87	82	90	102	50	56	90

5: Montmorency & St-Patrick Performance by movement

Movement	EBT	EBR	WBL	WBT	WBR	NBL	NBR	SBL	SBR	All
Denied Delay (hr)	43.7	0.0	0.0	0.0	0.0	0.0	0.0	0.0	0.0	43.7
Denied Del/Veh (s)	210.2	0.0	0.0	0.0	0.0	0.1	0.1	0.1	0.1	130.9
Total Delay (hr)	10.4	0.3	0.5	2.0	0.0	0.1	0.2	0.1	0.0	13.7
Total Del/Veh (s)	55.8	46.8	42.6	23.0	34.5	21.7	22.8	26.4	17.6	43.7
Vehicles Entered	664	20	45	310	3	21	39	10	5	1117
Vehicles Exited	663	20	45	310	3	21	38	10	5	1115
Hourly Exit Rate	663	20	45	310	3	21	38	10	5	1115
Input Volume	842	27	41	317	3	23	39	8	4	1304
% of Volume	79	74	110	98	100	91	97	125	125	86

6: Rue Bridge & Rue Saint-Patrick Performance by movement

Movement	EBT	EBR	WBL	WBT	NBL	All
Denied Delay (hr)	0.0	0.0	0.0	0.0	0.0	0.0
Denied Del/Veh (s)	0.0	0.0	0.0	0.0	0.0	0.0
Total Delay (hr)	0.2	18.9	6.5	1.1	1.1	27.8
Total Del/Veh (s)	38.2	98.3	27.7	13.7	16.4	48.2
Vehicles Entered	21	674	825	282	235	2037
Vehicles Exited	21	671	826	282	235	2035
Hourly Exit Rate	21	671	826	282	235	2035
Input Volume	83	790	829	282	239	2223
% of Volume	25	85	100	100	98	92

7: Rue Wellington & Rue Saint-Patrick Performance by movement

Movement	NBT	SBR	All
Denied Delay (hr)	0.0	0.5	0.5
Denied Del/Veh (s)	0.0	1.5	1.1
Total Delay (hr)	0.2	2.9	3.0
Total Del/Veh (s)	1.3	9.3	7.0
Vehicles Entered	442	1105	1547
Vehicles Exited	441	1104	1545
Hourly Exit Rate	441	1104	1545
Input Volume	492	1107	1599
% of Volume	90	100	97

8: rue Charlevoix & Rue Centre Performance by movement

Movement	EBL	EBT	EBR	WBL	WBT	WBR	NBL	NBT	NBR	SBL	SBT	SBR
Denied Delay (hr)	0.0	0.0	0.0	0.0	0.0	0.0	0.0	0.0	0.0	0.0	0.0	0.0
Denied Del/Veh (s)	0.2	0.2	0.3	0.0	0.0	0.0	0.3	0.2	0.3	0.0	0.0	0.0
Total Delay (hr)	0.4	1.1	0.2	0.1	0.2	0.2	0.0	1.0	0.1	0.1	0.4	0.0
Total Del/Veh (s)	18.6	18.2	19.1	26.3	18.1	20.6	17.0	14.3	19.3	20.7	10.8	21.9
Vehicles Entered	83	218	38	14	38	41	6	242	10	14	137	3
Vehicles Exited	83	219	37	14	38	42	6	243	10	14	137	3
Hourly Exit Rate	83	219	37	14	38	42	6	243	10	14	137	3
Input Volume	87	211	35	20	35	44	8	237	11	15	132	3
% of Volume	95	104	106	70	109	95	75	103	91	93	104	100

8: rue Charlevoix & Rue Centre Performance by movement

Movement	All
Denied Delay (hr)	0.0
Denied Del/Veh (s)	0.2
Total Delay (hr)	3.9
Total Del/Veh (s)	16.2
Vehicles Entered	844
Vehicles Exited	846
Hourly Exit Rate	846
Input Volume	838
% of Volume	101

**9: rue Sucrierie Performance by movement**

Movement	EBL	EBR	NBL	SBR	All
Denied Delay (hr)	0.0	0.0	0.0	0.0	0.0
Denied Del/Veh (s)	0.1	0.1	0.1	0.0	0.1
Total Delay (hr)	0.0	0.0	0.0	0.0	0.0
Total Del/Veh (s)	5.4	2.5	3.0	0.3	2.0
Vehicles Entered	14	5	26	44	89
Vehicles Exited	14	5	26	44	89
Hourly Exit Rate	14	5	26	44	89
Input Volume	18	3	27	48	96
% of Volume	78	167	96	92	93

**10: Montmorency Performance by movement**

Movement	NBT	SBT	All
Denied Delay (hr)	0.0	0.0	0.0
Denied Del/Veh (s)	0.0	0.0	0.0
Total Delay (hr)	0.0	0.0	0.0
Total Del/Veh (s)	0.0	0.6	0.5
Vehicles Entered	10	82	92
Vehicles Exited	10	83	93
Hourly Exit Rate	10	83	93
Input Volume	12	86	98
% of Volume	83	97	95

**11: Montmorency Performance by movement**

Movement	NBT	SBT	All
Denied Delay (hr)	0.0	0.0	0.0
Denied Del/Veh (s)	0.0	0.0	0.0
Total Delay (hr)	0.0	0.0	0.0
Total Del/Veh (s)	1.1	0.0	0.2
Vehicles Entered	10	83	93
Vehicles Exited	10	83	93
Hourly Exit Rate	10	83	93
Input Volume	12	86	98
% of Volume	83	97	95

12: Shearer & Centre Performance by movement

Movement	EBL	EBT	EBR	WBL	WBT	WBR	NBL	NBT	NBR	SBL	SBT	SBR
Denied Delay (hr)	0.0	0.0	0.0	0.0	0.0	0.0	0.0	0.0	0.0	0.8	1.1	0.2
Denied Del/Veh (s)	0.0	0.0	0.0	0.0	0.0	0.0	0.2	0.2	0.1	39.8	49.5	48.3
Total Delay (hr)	0.1	1.1	0.1	0.0	0.1	0.0	0.1	0.1	0.1	1.0	0.8	0.2
Total Del/Veh (s)	20.7	21.3	20.8	13.6	6.1	6.8	19.0	15.0	39.1	51.0	37.2	48.7
Vehicles Entered	12	181	22	6	41	4	10	33	9	68	74	17
Vehicles Exited	12	180	22	6	42	4	10	33	8	66	73	16
Hourly Exit Rate	12	180	22	6	42	4	10	33	8	66	73	16
Input Volume	12	179	19	8	47	5	10	30	7	74	86	18
% of Volume	100	101	116	75	89	80	100	110	114	89	85	89

12: Shearer & Centre Performance by movement

Movement	All
Denied Delay (hr)	2.1
Denied Del/Veh (s)	15.8
Total Delay (hr)	3.7
Total Del/Veh (s)	27.3
Vehicles Entered	477
Vehicles Exited	472
Hourly Exit Rate	472
Input Volume	495
% of Volume	95

13: rue Sucrierie & Centre Performance by movement

Movement	EBL	EBT	EBR	WBL	WBT	WBR	NBL	NBT	NBR	SBL	SBT	SBR
Denied Delay (hr)	0.0	0.7	0.1	0.0	0.0	0.0	0.0	0.0	0.0	0.1	0.0	0.0
Denied Del/Veh (s)	0.0	14.6	16.3	0.0	0.0	0.0	0.2	0.1	0.1	4.5	0.1	4.4
Total Delay (hr)	0.4	5.2	0.5	0.0	0.1	0.0	0.0	0.0	0.3	0.8	0.1	0.1
Total Del/Veh (s)	103.4	115.8	107.8	14.2	4.5	13.8	26.0	14.0	36.3	54.9	34.5	36.1
Vehicles Entered	14	160	18	10	75	3	5	9	29	50	12	11
Vehicles Exited	12	148	17	10	75	3	5	9	29	49	12	10
Hourly Exit Rate	12	148	17	10	75	3	5	9	29	49	12	10
Input Volume	14	169	18	8	77	5	7	9	26	54	13	11
% of Volume	86	88	94	125	97	60	71	100	112	91	92	91

13: rue Sucrierie & Centre Performance by movement

Movement	All
Denied Delay (hr)	0.8
Denied Del/Veh (s)	7.4
Total Delay (hr)	7.6
Total Del/Veh (s)	68.5
Vehicles Entered	396
Vehicles Exited	379
Hourly Exit Rate	379
Input Volume	411
% of Volume	92

14: rue Centre/Centre Performance by movement

Movement	EBL	EBT	WBT	WBR	SBL	SBR	All
Denied Delay (hr)	0.0	0.0	0.0	0.0	0.0	0.0	0.0
Denied Del/Veh (s)	0.0	0.0	0.1	0.1	0.0	0.0	0.0
Total Delay (hr)	0.1	6.1	0.0	0.0	0.9	0.2	7.3
Total Del/Veh (s)	71.8	100.3	0.2	0.1	449.0	253.2	76.9
Vehicles Entered	7	219	86	21	7	3	343
Vehicles Exited	7	208	85	21	4	3	328
Hourly Exit Rate	7	208	85	21	4	3	328
Input Volume	8	241	84	19	8	4	364
% of Volume	88	86	101	111	50	75	90

15: Rue Wellington & rue Centre/Accès Performance by movement

Movement	EBL	EBT	EBR	WBT	WBR	NBL	NBT	NBR	SBT	SBR	All
Denied Delay (hr)	2.4	0.0	0.0	0.0	0.0	0.0	0.0	0.0	0.0	0.0	2.4
Denied Del/Veh (s)	47.2	0.0		0.1	0.1	0.0	0.0	0.0	0.1	0.1	12.8
Total Delay (hr)	17.2	0.0	0.1	0.0	0.2	0.0	8.9	0.1	0.2	0.0	26.8
Total Del/Veh (s)	341.0	159.8		28.5	153.1	76.3	94.2	160.7	5.6	5.4	140.7
Vehicles Entered	177	1	0	1	4	1	339	3	130	23	679
Vehicles Exited	156	1	0	1	4	1	327	3	130	23	646
Hourly Exit Rate	156	1	0	1	4	1	327	3	130	23	646
Input Volume	213	1	1	1	3	2	344	2	129	24	720
% of Volume	73	100	0	100	133	50	95	150	101	96	90

16: Shearer & Richardson Performance by movement

Movement	WBL	WBT	WBR	NBT	SBT	All
Denied Delay (hr)	0.0	0.0	0.0	0.0	0.0	0.0
Denied Del/Veh (s)	0.0	0.0	0.0	0.0	0.0	0.0
Total Delay (hr)	0.0	0.0	0.0	0.0	0.0	0.1
Total Del/Veh (s)	5.3	1.1	4.1	1.0	0.7	1.4
Vehicles Entered	6	25	36	49	116	232
Vehicles Exited	6	25	36	49	116	232
Hourly Exit Rate	6	25	36	49	116	232
Input Volume	7	26	33	47	123	236
% of Volume	86	96	109	104	94	98

17: rue Sucrierie & Richardson Performance by movement

Movement	WBL	WBT	WBR	NBL	NBT	SBT	SBR	All
Denied Delay (hr)	0.0	0.0	0.0	0.0	0.0	0.0	0.0	0.0
Denied Del/Veh (s)	0.1	0.1	0.1	0.0	0.0	0.0	0.0	0.0
Total Delay (hr)	0.0	0.1	0.0	0.0	0.0	0.0	0.0	0.1
Total Del/Veh (s)	3.6	3.8	2.6	4.4	4.9	5.6	2.7	4.0
Vehicles Entered	7	49	7	15	15	2	3	98
Vehicles Exited	7	49	6	15	15	2	3	97
Hourly Exit Rate	7	49	6	15	15	2	3	97
Input Volume	8	46	5	19	16	2	1	97
% of Volume	88	107	120	79	94	100	300	100

18: Richardson & Montmorency Performance by movement

Movement	WBL	WBT	WBR	NBL	NBT	SBT	All
Denied Delay (hr)	0.0	0.0	0.0	0.0	0.0	0.0	0.0
Denied Del/Veh (s)	0.1	0.1	0.1	0.0	0.0	0.0	0.0
Total Delay (hr)	0.0	0.0	0.0	0.0	0.0	0.0	0.1
Total Del/Veh (s)	4.9	4.5	2.5	4.0	3.2	0.6	2.0
Vehicles Entered	1	19	1	17	10	73	121
Vehicles Exited	1	19	1	17	10	73	121
Hourly Exit Rate	1	19	1	17	10	73	121
Input Volume	2	18	1	16	11	77	125
% of Volume	50	106	100	106	91	95	97

19: rue de la Prairie & Rue Centre Performance by movement

Movement	EBT	WBT	All
Denied Delay (hr)	0.0	0.0	0.0
Denied Del/Veh (s)	0.0	0.1	0.0
Total Delay (hr)	0.5	0.2	0.6
Total Del/Veh (s)	7.0	6.9	7.0
Vehicles Entered	239	93	332
Vehicles Exited	240	93	333
Hourly Exit Rate	240	93	333
Input Volume	233	99	332
% of Volume	103	94	100

20: Rue Bridge & Rue Wellington Performance by movement

Movement	EBT	EBR	NBL	NBT	NBR	SBL	SBT	SBR	All
Denied Delay (hr)	8.9	18.8	0.0	0.0	0.0	0.0	0.0	0.0	27.8
Denied Del/Veh (s)	149.6	197.8	0.2	0.1	0.1	0.0	0.0	0.0	42.2
Total Delay (hr)	3.9	22.4	0.1	3.5	1.2	1.4	9.2	0.3	42.1
Total Del/Veh (s)	70.9	253.1	53.2	57.0	44.1	28.5	25.5	34.8	64.3
Vehicles Entered	195	303	6	212	100	179	1290	28	2313
Vehicles Exited	193	292	7	213	99	178	1287	28	2297
Hourly Exit Rate	193	292	7	213	99	178	1287	28	2297
Input Volume	248	379	6	214	99	179	1413	27	2565
% of Volume	78	77	117	100	100	99	91	104	90

21: Rue Ropery & Rue Centre Performance by movement

Movement	EBT	WBT	All
Denied Delay (hr)	0.0	0.0	0.0
Denied Del/Veh (s)	0.0	0.0	0.0
Total Delay (hr)	0.6	0.4	1.0
Total Del/Veh (s)	8.1	15.2	10.1
Vehicles Entered	244	93	337
Vehicles Exited	245	94	339
Hourly Exit Rate	245	94	339
Input Volume	238	99	337
% of Volume	103	95	101

23: Rue Island & Rue Centre Performance by movement

Movement	EBL	EBT	WBT	WBR	NBL	NBT	NBR	All
Denied Delay (hr)	0.0	0.0	0.0	0.0	0.0	0.0	0.0	0.0
Denied Del/Veh (s)	0.0	0.0	0.0	0.1	0.1	0.2	0.1	0.0
Total Delay (hr)	0.1	1.1	0.2	0.0	0.0	0.1	0.1	1.6
Total Del/Veh (s)	16.5	17.6	14.5	14.8	11.7	11.6	14.5	16.2
Vehicles Entered	13	215	61	12	4	23	21	349
Vehicles Exited	13	215	62	12	4	23	21	350
Hourly Exit Rate	13	215	62	12	4	23	21	350
Input Volume	13	209	70	12	5	24	20	353
% of Volume	100	103	89	100	80	96	105	99

40: Performance by movement

Movement	NBT	All
Denied Delay (hr)	0.0	0.0
Denied Del/Veh (s)	0.0	0.0
Total Delay (hr)	0.0	0.0
Total Del/Veh (s)	0.9	0.9
Vehicles Entered	49	49
Vehicles Exited	49	49
Hourly Exit Rate	49	49
Input Volume	49	49
% of Volume	100	100

45: St-Patrick/Rue Saint-Patrick Performance by movement

Movement	EBL	EBT	WBT	WBR	NBL	NBR	SBL	SBR	All
Denied Delay (hr)	0.0	3.8	0.0	0.0	0.0	0.0	0.0	0.0	3.8
Denied Del/Veh (s)	0.1	29.1	0.0	0.1	0.2	4.1	0.1	0.1	15.2
Total Delay (hr)	0.1	7.5	1.2	0.0	0.0	0.1	0.0	0.0	9.0
Total Del/Veh (s)	66.3	58.3	12.4	10.9	5.6	13.1	21.1	3.6	36.0
Vehicles Entered	6	458	361	2	32	30	5	4	898
Vehicles Exited	6	446	360	2	32	30	5	4	885
Hourly Exit Rate	6	446	360	2	32	30	5	4	885
Input Volume	5	479	351	2	35	29	5	3	909
% of Volume	120	93	103	100	91	103	100	133	97

Total Network Performance

Denied Delay (hr)	101.0
Denied Del/Veh (s)	70.1
Total Delay (hr)	215.0
Total Del/Veh (s)	148.2
Vehicles Entered	4957
Vehicles Exited	4797
Hourly Exit Rate	4797
Input Volume	23671
% of Volume	20



**Intersection: 1: rue St-Patrick & rue Charlevoix**

Movement	EB	EB	WB	WB	NB	NB	SB	SB
Directions Served	LT	R	LT	R	LT	R	LT	R
Maximum Queue (m)	158.7	37.5	54.0	36.4	137.2	14.5	74.2	16.8
Average Queue (m)	75.3	12.8	18.5	12.0	67.0	6.5	27.2	12.1
95th Queue (m)	132.9	39.1	38.6	27.4	127.2	16.5	53.9	18.8
Link Distance (m)	696.8		363.6		210.6		891.2	
Upstream Blk Time (%)					0			
Queuing Penalty (veh)					0			
Storage Bay Dist (m)		30.0		30.0		7.0		7.0
Storage Blk Time (%)	38	0	2	0	66	7	43	22
Queuing Penalty (veh)	12	1	2	0	16	27	31	34

**Intersection: 2: des Seigneurs & St-Patrick**

Movement	EB	EB	WB	WB	SB	SB
Directions Served	LT	TR	LT	R	LT	R
Maximum Queue (m)	161.7	67.5	65.0	40.0	206.4	17.5
Average Queue (m)	111.3	44.1	36.1	16.5	100.8	12.7
95th Queue (m)	196.7	93.3	61.6	32.6	200.2	23.0
Link Distance (m)	158.0		57.0	57.0	293.6	
Upstream Blk Time (%)	20		3			
Queuing Penalty (veh)	105		4			
Storage Bay Dist (m)		60.0				10.0
Storage Blk Time (%)	52	4			64	3
Queuing Penalty (veh)	109	12			68	11

**Intersection: 3: Shearer/Accès & St-Patrick**

Movement	EB	EB	WB	NB	NB
Directions Served	LT	R	LTR	LT	R
Maximum Queue (m)	63.0	11.8	51.3	76.1	22.0
Average Queue (m)	48.9	0.6	8.7	19.5	12.0
95th Queue (m)	82.8	4.8	30.3	62.9	24.1
Link Distance (m)	57.0	57.0	140.3	164.0	
Upstream Blk Time (%)	18				
Queuing Penalty (veh)	66				
Storage Bay Dist (m)					15.0
Storage Blk Time (%)				8	17
Queuing Penalty (veh)				4	9

**Intersection: 4: St-Patrick**

Movement	EB	WB	NB
Directions Served	TR	LT	LR
Maximum Queue (m)	146.4	58.7	47.7
Average Queue (m)	130.0	6.4	17.6
95th Queue (m)	190.1	31.8	45.4
Link Distance (m)	140.3	93.8	72.2
Upstream Blk Time (%)	28	0	2
Queuing Penalty (veh)	206	0	0
Storage Bay Dist (m)			
Storage Blk Time (%)			
Queuing Penalty (veh)			

**Intersection: 5: Montmorency & St-Patrick**

Movement	EB	EB	WB	NB	SB
Directions Served	T	R	LTR	LTR	LTR
Maximum Queue (m)	99.0	22.5	82.0	25.6	13.6
Average Queue (m)	96.4	3.5	41.5	9.7	2.8
95th Queue (m)	102.8	16.3	71.4	21.1	9.3
Link Distance (m)	93.8		195.1	54.9	54.7
Upstream Blk Time (%)	44				
Queuing Penalty (veh)	342				
Storage Bay Dist (m)		15.0			
Storage Blk Time (%)	65	0	51	27	9
Queuing Penalty (veh)	18	2	1	5	0

**Intersection: 6: Rue Bridge & Rue Saint-Patrick**

Movement	EB	WB	WB	NB
Directions Served	R	L	LT	L
Maximum Queue (m)	201.4	94.2	100.0	38.9
Average Queue (m)	197.5	64.9	70.6	13.8
95th Queue (m)	204.8	89.7	96.6	33.0
Link Distance (m)	195.1	258.4	258.4	165.7
Upstream Blk Time (%)	18			
Queuing Penalty (veh)	159			
Storage Bay Dist (m)				
Storage Blk Time (%)				
Queuing Penalty (veh)				

**Intersection: 7: Rue Wellington & Rue Saint-Patrick**

Movement	SB
Directions Served	R
Maximum Queue (m)	86.9
Average Queue (m)	8.7
95th Queue (m)	47.3
Link Distance (m)	252.0
Upstream Blk Time (%)	
Queuing Penalty (veh)	
Storage Bay Dist (m)	
Storage Blk Time (%)	
Queuing Penalty (veh)	

**Intersection: 8: rue Charlevoix & Rue Centre**

Movement	EB	WB	NB	SB
Directions Served	LTR	LTR	LTR	LTR
Maximum Queue (m)	67.8	38.8	50.4	40.9
Average Queue (m)	37.2	16.7	26.2	14.9
95th Queue (m)	58.3	31.2	44.0	31.7
Link Distance (m)	663.3	216.8	401.7	210.6
Upstream Blk Time (%)				
Queuing Penalty (veh)				
Storage Bay Dist (m)				
Storage Blk Time (%)	47	28		
Queuing Penalty (veh)	8	6		

**Intersection: 9: rue Sucrierie**

Movement	EB	NB	SB
Directions Served	LR	LT	TR
Maximum Queue (m)	9.1	7.3	1.4
Average Queue (m)	4.3	0.6	0.0
95th Queue (m)	11.6	4.5	1.0
Link Distance (m)	56.5	82.8	72.2
Upstream Blk Time (%)			
Queuing Penalty (veh)			
Storage Bay Dist (m)			
Storage Blk Time (%)			
Queuing Penalty (veh)			

Intersection: 10: Montmorency

Movement

Directions Served  
 Maximum Queue (m)  
 Average Queue (m)  
 95th Queue (m)  
 Link Distance (m)  
 Upstream Blk Time (%)  
 Queuing Penalty (veh)  
 Storage Bay Dist (m)  
 Storage Blk Time (%)  
 Queuing Penalty (veh)

Intersection: 11: Montmorency

Movement

Directions Served  
 Maximum Queue (m)  
 Average Queue (m)  
 95th Queue (m)  
 Link Distance (m)  
 Upstream Blk Time (%)  
 Queuing Penalty (veh)  
 Storage Bay Dist (m)  
 Storage Blk Time (%)  
 Queuing Penalty (veh)

Intersection: 12: Shearer & Centre

Movement	EB	EB	WB	WB	NB	SB
Directions Served	LT	R	LT	R	LTR	LTR
Maximum Queue (m)	66.0	15.1	22.5	4.9	23.0	56.9
Average Queue (m)	13.1	2.1	4.0	0.3	7.8	25.8
95th Queue (m)	57.2	10.2	13.7	2.6	18.5	55.5
Link Distance (m)	230.7		135.5		152.2	73.3
Upstream Blk Time (%)						3
Queuing Penalty (veh)						1
Storage Bay Dist (m)		15.0		15.0		
Storage Blk Time (%)	12	0	1		17	49
Queuing Penalty (veh)	2	0	0		1	4

**Intersection: 13: rue Sucrierie & Centre**

Movement	EB	WB	WB	NB	SB
Directions Served	LTR	LT	R	LTR	LTR
Maximum Queue (m)	134.5	18.7	5.7	22.4	36.5
Average Queue (m)	56.1	5.8	0.5	6.6	13.7
95th Queue (m)	137.7	15.1	3.3	18.1	32.8
Link Distance (m)	135.5	98.8		155.7	72.4
Upstream Blk Time (%)	14				
Queuing Penalty (veh)	27				
Storage Bay Dist (m)			15.0		
Storage Blk Time (%)	57	2		22	36
Queuing Penalty (veh)	5	0		3	2

**Intersection: 14: rue Centre/Centre**

Movement	EB	SB
Directions Served	LT	LR
Maximum Queue (m)	102.0	26.8
Average Queue (m)	47.9	8.8
95th Queue (m)	125.9	31.9
Link Distance (m)	98.8	72.2
Upstream Blk Time (%)	29	
Queuing Penalty (veh)	73	
Storage Bay Dist (m)		
Storage Blk Time (%)		
Queuing Penalty (veh)		

**Intersection: 15: Rue Wellington & rue Centre/Accès**

Movement	EB	WB	NB	NB	B37	SB	SB
Directions Served	LTR	LTR	LT	TR	T	LT	TR
Maximum Queue (m)	169.6	23.2	92.8	94.4	147.4	30.6	14.7
Average Queue (m)	129.9	4.3	48.5	63.0	27.3	10.3	2.7
95th Queue (m)	215.4	16.7	102.4	110.8	100.1	24.8	10.3
Link Distance (m)	165.7	202.1	75.8	75.8	296.5	172.8	172.8
Upstream Blk Time (%)	45		13	26			
Queuing Penalty (veh)	92		0	0			
Storage Bay Dist (m)							
Storage Blk Time (%)							
Queuing Penalty (veh)							

**Intersection: 16: Shearer & Richardson**

Movement	WB	NB	SB
Directions Served	LTR	T	TR
Maximum Queue (m)	11.9	3.6	4.3
Average Queue (m)	6.6	0.1	0.2
95th Queue (m)	13.3	1.9	3.5
Link Distance (m)	145.1	73.3	164.0
Upstream Blk Time (%)			
Queuing Penalty (veh)			
Storage Bay Dist (m)			
Storage Blk Time (%)			
Queuing Penalty (veh)			

**Intersection: 17: rue Sucrierie & Richardson**

Movement	WB	NB	SB
Directions Served	LTR	LT	TR
Maximum Queue (m)	16.7	9.1	9.2
Average Queue (m)	8.6	5.7	1.3
95th Queue (m)	14.2	12.7	6.5
Link Distance (m)	95.4	72.4	82.8
Upstream Blk Time (%)			
Queuing Penalty (veh)			
Storage Bay Dist (m)			
Storage Blk Time (%)			
Queuing Penalty (veh)			

**Intersection: 18: Richardson & Montmorency**

Movement	WB	NB	SB
Directions Served	LTR	LT	TR
Maximum Queue (m)	12.2	9.2	9.2
Average Queue (m)	4.6	5.2	2.5
95th Queue (m)	12.6	12.6	9.2
Link Distance (m)	197.3	72.2	35.2
Upstream Blk Time (%)			
Queuing Penalty (veh)			
Storage Bay Dist (m)			
Storage Blk Time (%)			
Queuing Penalty (veh)			

**Intersection: 19: rue de la Prairie & Rue Centre**

Movement	EB	WB
Directions Served	LTR	LTR
Maximum Queue (m)	29.9	18.4
Average Queue (m)	13.1	7.3
95th Queue (m)	25.3	16.9
Link Distance (m)	127.6	127.0
Upstream Blk Time (%)		
Queuing Penalty (veh)		
Storage Bay Dist (m)		
Storage Blk Time (%)		
Queuing Penalty (veh)		

**Intersection: 20: Rue Bridge & Rue Wellington**

Movement	EB	EB	NB	NB	NB	SB	SB	SB
Directions Served	T	TR	LT	TR	R	LT	T	R
Maximum Queue (m)	185.7	181.6	41.2	44.4	33.1	159.6	158.4	8.7
Average Queue (m)	114.4	171.1	25.5	25.5	12.6	80.7	84.3	4.0
95th Queue (m)	222.7	196.8	38.5	38.9	25.6	146.4	149.6	10.2
Link Distance (m)	172.8	172.8	694.3	694.3		165.7	165.7	
Upstream Blk Time (%)	12	59				0	1	
Queuing Penalty (veh)	34	164				3	5	
Storage Bay Dist (m)					60.0			0.1
Storage Blk Time (%)		81					47	3
Queuing Penalty (veh)		154					13	17

**Intersection: 21: Rue Ropery & Rue Centre**

Movement	EB	WB
Directions Served	LT	LT
Maximum Queue (m)	34.1	31.9
Average Queue (m)	14.1	14.1
95th Queue (m)	27.1	26.6
Link Distance (m)	216.8	127.6
Upstream Blk Time (%)		
Queuing Penalty (veh)		
Storage Bay Dist (m)		
Storage Blk Time (%)	12	1
Queuing Penalty (veh)	0	0

**Intersection: 23: Rue Island & Rue Centre**

Movement	EB	WB	NB
Directions Served	LT	TR	LTR
Maximum Queue (m)	48.2	29.8	22.9
Average Queue (m)	24.8	9.0	7.6
95th Queue (m)	41.5	20.8	18.3
Link Distance (m)	127.0	230.7	153.9
Upstream Blk Time (%)			
Queuing Penalty (veh)			
Storage Bay Dist (m)			
Storage Blk Time (%)			13
Queuing Penalty (veh)			1

**Intersection: 40:**

Movement
Directions Served
Maximum Queue (m)
Average Queue (m)
95th Queue (m)
Link Distance (m)
Upstream Blk Time (%)
Queuing Penalty (veh)
Storage Bay Dist (m)
Storage Blk Time (%)
Queuing Penalty (veh)

**Intersection: 45: St-Patrick/Rue Saint-Patrick**

Movement	EB	B39	WB	NB	NB	SB	SB
Directions Served	LT	T	TR	LT	R	L	R
Maximum Queue (m)	121.8	76.7	55.5	20.4	15.0	8.9	8.9
Average Queue (m)	69.0	8.7	24.3	6.5	7.1	1.7	1.1
95th Queue (m)	170.4	61.9	44.5	15.4	16.7	7.4	5.8
Link Distance (m)	157.6	363.6	158.0			57.1	57.1
Upstream Blk Time (%)	10						
Queuing Penalty (veh)	42						
Storage Bay Dist (m)					10.0		
Storage Blk Time (%)				3	8		
Queuing Penalty (veh)				1	3		

**Network Summary**

Network wide Queuing Penalty: 1902
------------------------------------



1: rue St-Patrick & rue Charlevoix Performance by movement

Movement	EBL	EBT	EBR	WBL	WBT	WBR	NBL	NBT	NBR	SBL	SBT	SBR
Denied Delay (hr)	0.0	0.0	0.0	0.0	0.0	0.0	0.0	0.0	0.0	0.0	0.0	0.0
Denied Del/Veh (s)	0.4	0.4	1.0	0.0	0.0	0.0	0.0	0.2	0.1	0.2	0.2	0.2
Total Delay (hr)	1.9	3.1	0.3	0.0	0.6	0.3	1.3	2.9	0.3	0.3	0.8	0.5
Total Del/Veh (s)	32.9	32.2	27.9	13.5	7.2	11.6	41.1	42.4	40.9	24.4	22.8	23.2
Vehicles Entered	203	339	33	4	291	97	111	245	26	41	116	72
Vehicles Exited	205	342	33	4	290	97	107	241	25	40	116	69
Hourly Exit Rate	205	342	33	4	290	97	107	241	25	40	116	69
Input Volume	206	346	32	5	283	101	115	244	24	37	113	73
% of Volume	100	99	103	80	102	96	93	99	104	108	103	95

1: rue St-Patrick & rue Charlevoix Performance by movement

Movement	All
Denied Delay (hr)	0.1
Denied Del/Veh (s)	0.2
Total Delay (hr)	12.2
Total Del/Veh (s)	27.4
Vehicles Entered	1578
Vehicles Exited	1569
Hourly Exit Rate	1569
Input Volume	1579
% of Volume	99

2: des Seigneurs & St-Patrick Performance by movement

Movement	EBL	EBT	EBR	WBL	WBT	WBR	SBL	SBT	SBR	All
Denied Delay (hr)	0.0	0.0	0.0	0.0	0.0	0.0	0.1	0.0	0.1	0.2
Denied Del/Veh (s)	0.0	0.0	0.3	1.9	0.4	0.0	0.6	0.4	3.4	0.5
Total Delay (hr)	1.1	3.7	0.0	0.0	1.4	0.6	2.8	0.0	0.7	10.3
Total Del/Veh (s)	36.6	32.1	28.5	23.5	19.3	18.4	28.9	27.9	21.6	27.2
Vehicles Entered	105	411	5	7	250	118	339	5	111	1351
Vehicles Exited	104	412	5	7	250	117	339	5	110	1349
Hourly Exit Rate	104	412	5	7	250	117	339	5	110	1349
Input Volume	107	411	4	7	256	115	343	5	106	1354
% of Volume	97	100	125	100	98	102	99	100	104	100

**3: Shearer/Accès & St-Patrick Performance by movement**

Movement	EBL	EBT	EBR	WBL	WBT	NBL	NBR	All
Denied Delay (hr)	0.0	0.0	0.0	0.0	0.0	0.0	0.0	0.1
Denied Del/Veh (s)	0.0	0.2	0.0	0.2	0.1	0.1	1.1	0.2
Total Delay (hr)	0.0	0.3	0.0	0.1	0.2	0.3	0.1	1.0
Total Del/Veh (s)	2.6	1.5	0.9	8.5	2.6	18.5	7.8	2.8
Vehicles Entered	1	748	87	35	294	48	49	1262
Vehicles Exited	1	747	87	34	293	49	49	1260
Hourly Exit Rate	1	747	87	34	293	49	49	1260
Input Volume	1	746	88	35	294	51	50	1265
% of Volume	100	100	99	97	100	96	98	100

**4: St-Patrick Performance by movement**

Movement	EBT	EBR	WBL	WBT	NBL	NBR	All
Denied Delay (hr)	0.0	0.0	0.0	0.0	0.0	0.0	0.0
Denied Del/Veh (s)	0.0	0.0	0.0	0.1	0.0	0.0	0.0
Total Delay (hr)	0.2	0.0	0.0	0.2	0.0	0.0	0.5
Total Del/Veh (s)	1.3	0.7	6.5	2.5	10.7	6.5	1.8
Vehicles Entered	710	20	25	288	10	8	1061
Vehicles Exited	711	20	24	288	10	9	1062
Hourly Exit Rate	711	20	24	288	10	9	1062
Input Volume	710	17	21	288	10	9	1055
% of Volume	100	118	114	100	100	100	101

**5: Montmorency & St-Patrick Performance by movement**

Movement	EBT	EBR	WBL	WBT	WBR	NBL	NBR	SBL	SBR	All
Denied Delay (hr)	0.1	0.0	0.0	0.0	0.0	0.0	0.0	0.0	0.0	0.1
Denied Del/Veh (s)	0.6	0.0	0.0	0.0	0.0	0.1	0.1	0.1	0.1	0.3
Total Delay (hr)	2.6	0.1	0.4	1.5	0.0	0.1	0.2	0.1	0.0	5.0
Total Del/Veh (s)	14.8	14.2	33.7	16.4	30.6	21.6	20.5	26.8	23.2	16.4
Vehicles Entered	625	29	41	327	3	18	35	9	4	1091
Vehicles Exited	623	29	41	327	3	17	34	9	4	1087
Hourly Exit Rate	623	29	41	327	3	17	34	9	4	1087
Input Volume	629	27	41	317	3	23	39	8	4	1091
% of Volume	99	107	100	103	100	74	87	112	100	100

6: Rue Bridge & Rue Saint-Patrick Performance by movement

Movement	EBT	EBR	WBL	WBT	NBL	All
Denied Delay (hr)	0.0	0.0	0.0	0.0	0.0	0.0
Denied Del/Veh (s)	0.0	0.0	0.0	0.0	0.0	0.0
Total Delay (hr)	0.2	6.6	6.9	1.2	1.1	16.0
Total Del/Veh (s)	6.2	42.0	29.4	14.7	17.0	28.0
Vehicles Entered	112	554	828	296	239	2029
Vehicles Exited	112	554	833	297	240	2036
Hourly Exit Rate	112	554	833	297	240	2036
Input Volume	111	565	829	282	239	2026
% of Volume	101	98	100	105	100	100

7: Rue Wellington & Rue Saint-Patrick Performance by movement

Movement	NBT	SBR	All
Denied Delay (hr)	0.0	0.5	0.5
Denied Del/Veh (s)	0.0	1.6	1.1
Total Delay (hr)	0.1	3.0	3.1
Total Del/Veh (s)	1.1	9.5	7.0
Vehicles Entered	462	1119	1581
Vehicles Exited	461	1119	1580
Hourly Exit Rate	461	1119	1580
Input Volume	492	1107	1599
% of Volume	94	101	99

8: rue Charlevoix & Rue Centre Performance by movement

Movement	EBL	EBT	EBR	WBL	WBT	WBR	NBL	NBT	NBR	SBL	SBT	SBR
Denied Delay (hr)	0.0	0.0	0.0	0.0	0.0	0.0	0.0	0.0	0.0	0.0	0.0	0.0
Denied Del/Veh (s)	0.3	0.2	0.3	0.0	0.0	0.0	0.2	0.2	0.2	0.0	0.0	0.0
Total Delay (hr)	0.5	1.1	0.2	0.1	0.2	0.2	0.0	1.0	0.1	0.1	0.4	0.0
Total Del/Veh (s)	19.2	18.5	20.1	27.0	17.4	19.7	16.9	14.2	17.2	18.7	11.3	19.1
Vehicles Entered	86	205	36	15	34	41	9	240	14	16	133	3
Vehicles Exited	86	206	35	15	34	40	9	241	14	16	132	3
Hourly Exit Rate	86	206	35	15	34	40	9	241	14	16	132	3
Input Volume	87	211	35	20	35	44	8	237	11	15	132	3
% of Volume	99	98	100	75	97	91	112	102	127	107	100	100

8: rue Charlevoix & Rue Centre Performance by movement

Movement	All
Denied Delay (hr)	0.0
Denied Del/Veh (s)	0.2
Total Delay (hr)	3.9
Total Del/Veh (s)	16.5
Vehicles Entered	832
Vehicles Exited	831
Hourly Exit Rate	831
Input Volume	838
% of Volume	99

**9: rue Sucrierie Performance by movement**

Movement	EBL	EBR	NBL	SBR	All
Denied Delay (hr)	0.0	0.0	0.0	0.0	0.0
Denied Del/Veh (s)	0.1	0.1	0.0	0.0	0.0
Total Delay (hr)	0.0	0.0	0.0	0.0	0.1
Total Del/Veh (s)	3.9	2.6	3.0	0.4	1.8
Vehicles Entered	18	3	27	54	102
Vehicles Exited	17	3	27	54	101
Hourly Exit Rate	17	3	27	54	101
Input Volume	18	3	27	48	96
% of Volume	94	100	100	112	105

**10: Montmorency Performance by movement**

Movement	NBT	SBT	All
Denied Delay (hr)	0.0	0.0	0.0
Denied Del/Veh (s)	0.0	0.0	0.0
Total Delay (hr)	0.0	0.0	0.0
Total Del/Veh (s)	0.0	0.6	0.5
Vehicles Entered	11	85	96
Vehicles Exited	11	84	95
Hourly Exit Rate	11	84	95
Input Volume	12	86	98
% of Volume	92	98	97

**11: Montmorency Performance by movement**

Movement	NBT	SBT	All
Denied Delay (hr)	0.0	0.0	0.0
Denied Del/Veh (s)	0.0	0.0	0.0
Total Delay (hr)	0.0	0.0	0.0
Total Del/Veh (s)	1.0	0.0	0.1
Vehicles Entered	11	84	95
Vehicles Exited	11	85	96
Hourly Exit Rate	11	85	96
Input Volume	12	86	98
% of Volume	92	99	98

12: Shearer & Centre Performance by movement

Movement	EBL	EBT	EBR	WBL	WBT	WBR	NBL	NBT	NBR	SBL	SBT	SBR
Denied Delay (hr)	0.0	0.0	0.0	0.0	0.0	0.0	0.0	0.0	0.0	0.0	0.0	0.0
Denied Del/Veh (s)	0.0	0.0	0.0	0.0	0.0	0.0	0.1	0.1	0.1	0.2	0.3	0.1
Total Delay (hr)	0.0	0.2	0.0	0.0	0.1	0.0	0.0	0.1	0.0	0.4	0.4	0.1
Total Del/Veh (s)	6.7	4.5	7.6	8.6	5.7	11.2	16.0	11.3	14.0	17.9	16.3	17.5
Vehicles Entered	10	176	23	6	48	5	8	29	8	73	88	17
Vehicles Exited	10	176	23	6	48	5	8	29	8	73	89	17
Hourly Exit Rate	10	176	23	6	48	5	8	29	8	73	89	17
Input Volume	12	179	19	8	47	5	10	30	7	74	86	18
% of Volume	83	98	121	75	102	100	80	97	114	99	103	94

12: Shearer & Centre Performance by movement

Movement	All
Denied Delay (hr)	0.0
Denied Del/Veh (s)	0.1
Total Delay (hr)	1.4
Total Del/Veh (s)	10.2
Vehicles Entered	491
Vehicles Exited	492
Hourly Exit Rate	492
Input Volume	495
% of Volume	99

13: rue Sucrierie & Centre Performance by movement

Movement	EBL	EBT	EBR	WBL	WBT	WBR	NBL	NBT	NBR	SBL	SBT	SBR
Denied Delay (hr)	0.0	0.0	0.0	0.0	0.0	0.0	0.0	0.0	0.0	0.0	0.0	0.0
Denied Del/Veh (s)	0.0	0.0	0.1	0.0	0.0	0.0	0.2	0.1	0.1	0.1	0.2	0.1
Total Delay (hr)	0.1	0.7	0.1	0.0	0.1	0.0	0.0	0.0	0.1	0.2	0.1	0.0
Total Del/Veh (s)	15.2	13.8	12.0	11.3	4.5	10.7	16.5	12.9	13.0	15.3	14.1	12.0
Vehicles Entered	13	174	16	7	73	6	5	9	27	50	13	11
Vehicles Exited	13	173	16	7	73	6	5	9	27	50	13	11
Hourly Exit Rate	13	173	16	7	73	6	5	9	27	50	13	11
Input Volume	14	169	18	8	77	5	7	9	26	54	13	11
% of Volume	93	102	89	88	95	120	71	100	104	93	100	100

13: rue Sucrierie & Centre Performance by movement

Movement	All
Denied Delay (hr)	0.0
Denied Del/Veh (s)	0.0
Total Delay (hr)	1.4
Total Del/Veh (s)	12.1
Vehicles Entered	404
Vehicles Exited	403
Hourly Exit Rate	403
Input Volume	411
% of Volume	98

14: rue Centre/Centre Performance by movement

Movement	EBL	EBT	WBT	WBR	SBL	SBR	All
Denied Delay (hr)	0.0	0.0	0.0	0.0	0.0	0.0	0.0
Denied Del/Veh (s)	0.0	0.0	0.1	0.1	0.0	0.0	0.0
Total Delay (hr)	0.0	0.1	0.0	0.0	0.0	0.0	0.1
Total Del/Veh (s)	3.1	1.4	0.3	0.1	6.1	3.5	1.2
Vehicles Entered	8	243	79	18	6	4	358
Vehicles Exited	8	243	79	18	6	4	358
Hourly Exit Rate	8	243	79	18	6	4	358
Input Volume	8	241	84	19	8	4	364
% of Volume	100	101	94	95	75	100	98

15: Rue Wellington & rue Centre/Accès Performance by movement

Movement	EBL	EBR	WBT	WBR	NBL	NBT	NBR	SBT	SBR	All
Denied Delay (hr)	6.0	0.0	0.0	0.0	0.0	0.0	0.0	0.0	0.0	6.1
Denied Del/Veh (s)	98.9	153.7	0.1	0.1	0.0	0.0	0.0	0.1	0.1	28.9
Total Delay (hr)	7.6	0.1	0.0	0.0	0.0	5.7	0.1	0.2	0.0	13.8
Total Del/Veh (s)	139.3	187.3	20.5	57.3	56.0	55.8	90.3	5.2	4.0	67.6
Vehicles Entered	194	1	1	3	3	370	2	130	26	730
Vehicles Exited	185	1	1	3	3	361	2	129	26	711
Hourly Exit Rate	185	1	1	3	3	361	2	129	26	711
Input Volume	223	1	1	3	3	363	2	131	27	754
% of Volume	83	100	100	100	100	99	100	98	96	94

16: Shearer & Richardson Performance by movement

Movement	WBL	WBT	WBR	NBT	SBT	All
Denied Delay (hr)	0.0	0.0	0.0	0.0	0.0	0.0
Denied Del/Veh (s)	0.0	0.0	0.0	0.0	0.0	0.0
Total Delay (hr)	0.0	0.0	0.0	0.0	0.0	0.1
Total Del/Veh (s)	5.7	1.2	4.3	0.9	0.3	1.3
Vehicles Entered	6	24	36	43	121	230
Vehicles Exited	6	24	36	43	121	230
Hourly Exit Rate	6	24	36	43	121	230
Input Volume	7	26	33	47	123	236
% of Volume	86	92	109	91	98	97

17: rue Sucrierie & Richardson Performance by movement

Movement	WBL	WBT	WBR	NBL	NBT	SBT	SBR	All
Denied Delay (hr)	0.0	0.0	0.0	0.0	0.0	0.0	0.0	0.0
Denied Del/Veh (s)	0.0	0.1	0.0	0.0	0.0	0.0	0.0	0.0
Total Delay (hr)	0.0	0.1	0.0	0.0	0.0	0.0	0.0	0.1
Total Del/Veh (s)	3.7	3.8	2.8	4.4	5.0	3.5	2.2	4.0
Vehicles Entered	8	48	6	17	16	2	2	99
Vehicles Exited	8	48	6	17	16	2	2	99
Hourly Exit Rate	8	48	6	17	16	2	2	99
Input Volume	8	46	5	19	16	2	1	97
% of Volume	100	104	120	89	100	100	200	102

18: Richardson & Montmorency Performance by movement

Movement	WBL	WBT	WBR	NBL	NBT	SBT	All
Denied Delay (hr)	0.0	0.0	0.0	0.0	0.0	0.0	0.0
Denied Del/Veh (s)	0.4	0.1	0.4	0.0	0.0	0.0	0.0
Total Delay (hr)	0.0	0.0	0.0	0.0	0.0	0.0	0.1
Total Del/Veh (s)	5.6	4.4	4.4	3.9	2.7	0.4	1.8
Vehicles Entered	1	19	1	17	9	75	122
Vehicles Exited	1	19	1	17	10	75	123
Hourly Exit Rate	1	19	1	17	10	75	123
Input Volume	2	18	1	16	11	77	125
% of Volume	50	106	100	106	91	97	98

19: rue de la Prairie & Rue Centre Performance by movement

Movement	EBT	WBT	All
Denied Delay (hr)	0.0	0.0	0.0
Denied Del/Veh (s)	0.0	0.1	0.0
Total Delay (hr)	0.4	0.2	0.6
Total Del/Veh (s)	6.3	6.7	6.4
Vehicles Entered	233	90	323
Vehicles Exited	232	90	322
Hourly Exit Rate	232	90	322
Input Volume	233	99	332
% of Volume	100	91	97

20: Rue Bridge & Rue Wellington Performance by movement

Movement	EBT	EBR	NBL	NBT	NBR	SBL	SBT	SBR	All
Denied Delay (hr)	0.0	0.0	0.0	0.0	0.0	0.0	0.0	0.0	0.0
Denied Del/Veh (s)	0.0	0.0	0.1	0.1	0.1	0.0	0.1	0.0	0.1
Total Delay (hr)	9.5	21.5	0.1	3.4	1.2	1.5	10.1	0.3	47.5
Total Del/Veh (s)	138.7	239.6	53.4	56.1	42.9	29.3	30.2	36.1	74.2
Vehicles Entered	243	306	6	209	102	176	1186	27	2255
Vehicles Exited	230	297	6	211	100	178	1189	27	2238
Hourly Exit Rate	230	297	6	211	100	178	1189	27	2238
Input Volume	263	326	6	214	99	179	1190	27	2304
% of Volume	87	91	100	99	101	99	100	100	97

21: Rue Ropery & Rue Centre Performance by movement

Movement	EBT	WBT	All
Denied Delay (hr)	0.0	0.0	0.0
Denied Del/Veh (s)	0.0	0.0	0.0
Total Delay (hr)	0.6	0.4	1.0
Total Del/Veh (s)	8.4	16.2	10.5
Vehicles Entered	238	90	328
Vehicles Exited	239	91	330
Hourly Exit Rate	239	91	330
Input Volume	238	99	337
% of Volume	100	92	98

23: Rue Island & Rue Centre Performance by movement

Movement	EBL	EBT	WBT	WBR	NBL	NBT	NBR	All
Denied Delay (hr)	0.0	0.0	0.0	0.0	0.0	0.0	0.0	0.0
Denied Del/Veh (s)	0.0	0.0	0.0	0.0	0.1	0.2	0.1	0.0
Total Delay (hr)	0.1	1.0	0.3	0.1	0.0	0.1	0.1	1.6
Total Del/Veh (s)	18.5	17.9	15.6	18.1	10.8	9.6	13.7	16.6
Vehicles Entered	13	204	63	12	5	25	20	342
Vehicles Exited	13	205	63	12	5	25	20	343
Hourly Exit Rate	13	205	63	12	5	25	20	343
Input Volume	13	209	70	12	5	24	20	353
% of Volume	100	98	90	100	100	104	100	97



40: Performance by movement

Movement	NBT	All
Denied Delay (hr)	0.0	0.0
Denied Del/Veh (s)	0.0	0.0
Total Delay (hr)	0.0	0.0
Total Del/Veh (s)	0.9	0.9
Vehicles Entered	50	50
Vehicles Exited	50	50
Hourly Exit Rate	50	50
Input Volume	49	49
% of Volume	102	102

45: St-Patrick/Rue Saint-Patrick Performance by movement

Movement	EBL	EBT	WBT	WBR	NBL	NBR	SBL	SBR	All
Denied Delay (hr)	0.0	0.0	0.0	0.0	0.0	0.0	0.0	0.0	0.1
Denied Del/Veh (s)	0.1	0.1	0.0	0.0	0.2	4.0	0.1	0.1	0.2
Total Delay (hr)	0.0	1.6	1.1	0.0	0.0	0.0	0.0	0.0	2.8
Total Del/Veh (s)	7.7	12.0	10.9	9.0	5.6	4.3	3.7	4.3	11.0
Vehicles Entered	5	476	355	3	31	31	3	4	908
Vehicles Exited	5	478	355	3	31	31	3	4	910
Hourly Exit Rate	5	478	355	3	31	31	3	4	910
Input Volume	5	479	351	2	35	29	5	3	909
% of Volume	100	100	101	150	89	107	60	133	100

Total Network Performance

Denied Delay (hr)	7.2
Denied Del/Veh (s)	5.2
Total Delay (hr)	127.9
Total Del/Veh (s)	87.6
Vehicles Entered	5036
Vehicles Exited	4974
Hourly Exit Rate	4974
Input Volume	22741
% of Volume	22

Intersection: 1: rue St-Patrick & rue Charlevoix

Movement	EB	EB	WB	WB	NB	NB	SB	SB
Directions Served	LT	R	LT	R	LT	R	LT	R
Maximum Queue (m)	161.9	37.5	48.4	36.4	147.1	14.5	49.6	18.8
Average Queue (m)	72.2	9.5	17.5	11.9	63.1	7.2	24.8	11.6
95th Queue (m)	135.8	32.5	34.9	28.2	114.8	17.8	44.8	19.6
Link Distance (m)	696.8		363.6		210.6		891.2	
Upstream Blk Time (%)					0			
Queuing Penalty (veh)					0			
Storage Bay Dist (m)		30.0		30.0		7.0		7.0
Storage Blk Time (%)	37	0	2	0	65	7	41	24
Queuing Penalty (veh)	12	0	2	1	16	26	30	36

Intersection: 2: des Seigneurs & St-Patrick

Movement	EB	EB	WB	WB	SB	SB
Directions Served	LT	TR	LT	R	LT	R
Maximum Queue (m)	126.9	66.9	61.6	34.1	97.4	17.5
Average Queue (m)	59.3	20.6	30.2	15.5	54.7	13.0
95th Queue (m)	113.5	62.2	54.2	29.3	88.0	23.1
Link Distance (m)	158.0		57.0	57.0	293.6	
Upstream Blk Time (%)	1		1			
Queuing Penalty (veh)	4		2			
Storage Bay Dist (m)		60.0				10.0
Storage Blk Time (%)	13	1			48	6
Queuing Penalty (veh)	28	2			51	21

Intersection: 3: Shearer/Accès & St-Patrick

Movement	EB	EB	WB	NB	NB
Directions Served	LT	R	LTR	LT	R
Maximum Queue (m)	23.0	10.8	48.4	29.7	21.3
Average Queue (m)	2.0	0.7	8.1	9.2	7.3
95th Queue (m)	12.1	5.3	27.8	20.7	16.9
Link Distance (m)	57.0	57.0	140.3	164.0	
Upstream Blk Time (%)					
Queuing Penalty (veh)					
Storage Bay Dist (m)					15.0
Storage Blk Time (%)				5	1
Queuing Penalty (veh)				2	0

**Intersection: 4: St-Patrick**

Movement	EB	WB	NB
Directions Served	TR	LT	LR
Maximum Queue (m)	10.8	40.7	11.9
Average Queue (m)	0.8	6.4	4.1
95th Queue (m)	6.4	23.8	11.9
Link Distance (m)	140.3	93.8	72.2
Upstream Blk Time (%)			
Queuing Penalty (veh)			
Storage Bay Dist (m)			
Storage Blk Time (%)			
Queuing Penalty (veh)			

**Intersection: 5: Montmorency & St-Patrick**

Movement	EB	EB	WB	NB	SB
Directions Served	T	R	LTR	LTR	LTR
Maximum Queue (m)	94.9	22.5	79.0	23.9	12.6
Average Queue (m)	58.5	3.8	35.3	7.7	2.9
95th Queue (m)	92.6	15.9	62.2	17.8	9.3
Link Distance (m)	93.8		195.1	54.9	54.7
Upstream Blk Time (%)	1				
Queuing Penalty (veh)	3				
Storage Bay Dist (m)		15.0			
Storage Blk Time (%)	33	0	44	23	8
Queuing Penalty (veh)	9	2	0	4	0

**Intersection: 6: Rue Bridge & Rue Saint-Patrick**

Movement	EB	WB	WB	NB
Directions Served	R	L	LT	L
Maximum Queue (m)	185.5	106.4	111.0	44.2
Average Queue (m)	105.3	67.9	74.4	15.6
95th Queue (m)	165.6	94.2	100.9	36.6
Link Distance (m)	195.1	258.4	258.4	165.7
Upstream Blk Time (%)	0			
Queuing Penalty (veh)	2			
Storage Bay Dist (m)				
Storage Blk Time (%)				
Queuing Penalty (veh)				

Intersection: 7: Rue Wellington & Rue Saint-Patrick

Movement	SB
Directions Served	R
Maximum Queue (m)	116.8
Average Queue (m)	13.9
95th Queue (m)	74.5
Link Distance (m)	252.0
Upstream Blk Time (%)	0
Queuing Penalty (veh)	0
Storage Bay Dist (m)	
Storage Blk Time (%)	
Queuing Penalty (veh)	

Intersection: 8: rue Charlevoix & Rue Centre

Movement	EB	WB	NB	SB
Directions Served	LTR	LTR	LTR	LTR
Maximum Queue (m)	70.3	38.8	58.0	37.4
Average Queue (m)	36.2	16.4	25.9	13.9
95th Queue (m)	60.3	32.0	45.7	28.4
Link Distance (m)	663.3	216.8	401.7	210.6
Upstream Blk Time (%)				
Queuing Penalty (veh)				
Storage Bay Dist (m)				
Storage Blk Time (%)	48	27		
Queuing Penalty (veh)	8	6		

Intersection: 9: rue Sucrierie

Movement	EB	NB
Directions Served	LR	LT
Maximum Queue (m)	10.5	7.3
Average Queue (m)	4.1	0.6
95th Queue (m)	11.5	4.2
Link Distance (m)	56.5	82.8
Upstream Blk Time (%)		
Queuing Penalty (veh)		
Storage Bay Dist (m)		
Storage Blk Time (%)		
Queuing Penalty (veh)		

Intersection: 10: Montmorency

Movement

Directions Served  
 Maximum Queue (m)  
 Average Queue (m)  
 95th Queue (m)  
 Link Distance (m)  
 Upstream Blk Time (%)  
 Queuing Penalty (veh)  
 Storage Bay Dist (m)  
 Storage Blk Time (%)  
 Queuing Penalty (veh)

Intersection: 11: Montmorency

Movement

Directions Served  
 Maximum Queue (m)  
 Average Queue (m)  
 95th Queue (m)  
 Link Distance (m)  
 Upstream Blk Time (%)  
 Queuing Penalty (veh)  
 Storage Bay Dist (m)  
 Storage Blk Time (%)  
 Queuing Penalty (veh)

Intersection: 12: Shearer & Centre

Movement	EB	EB	WB	WB	NB	SB
Directions Served	LT	R	LT	R	LTR	LTR
Maximum Queue (m)	19.8	10.7	16.1	10.1	15.0	44.2
Average Queue (m)	5.1	1.0	3.6	0.7	5.7	21.0
95th Queue (m)	15.0	5.3	11.8	4.8	13.1	36.6
Link Distance (m)	230.7		135.5		152.2	73.3
Upstream Blk Time (%)						
Queuing Penalty (veh)						
Storage Bay Dist (m)		15.0		15.0		
Storage Blk Time (%)	2	0	1	0	13	41
Queuing Penalty (veh)	0	0	0	0	0	4

**Intersection: 13: rue Sucrierie & Centre**

Movement	EB	WB	WB	NB	SB
Directions Served	LTR	LT	R	LTR	LTR
Maximum Queue (m)	45.2	21.4	9.5	19.2	24.0
Average Queue (m)	21.1	6.3	0.8	5.1	9.4
95th Queue (m)	37.8	16.5	5.0	14.4	20.6
Link Distance (m)	135.5	98.8		155.7	72.4
Upstream Blk Time (%)					
Queuing Penalty (veh)					
Storage Bay Dist (m)			15.0		
Storage Blk Time (%)	32	2	0	12	20
Queuing Penalty (veh)	3	0	0	2	1

**Intersection: 14: rue Centre/Centre**

Movement	EB	SB
Directions Served	LT	LR
Maximum Queue (m)	7.6	9.2
Average Queue (m)	0.9	2.5
95th Queue (m)	6.4	9.1
Link Distance (m)	98.8	72.2
Upstream Blk Time (%)		
Queuing Penalty (veh)		
Storage Bay Dist (m)		
Storage Blk Time (%)		
Queuing Penalty (veh)		

**Intersection: 15: Rue Wellington & rue Centre/Accès**

Movement	EB	WB	NB	NB	B37	SB	SB
Directions Served	LTR	LTR	LT	TR	T	LT	TR
Maximum Queue (m)	134.5	19.3	84.3	78.4	87.3	30.2	14.6
Average Queue (m)	74.7	2.5	38.3	37.3	15.0	9.7	2.4
95th Queue (m)	150.8	12.0	89.2	84.4	94.6	24.0	9.8
Link Distance (m)	165.7	202.1	75.8	75.8	296.5	172.8	172.8
Upstream Blk Time (%)	2		8	6	1		
Queuing Penalty (veh)	2		0	0	0		
Storage Bay Dist (m)							
Storage Blk Time (%)							
Queuing Penalty (veh)							

**Intersection: 16: Shearer & Richardson**

Movement	WB	NB	SB
Directions Served	LTR	T	TR
Maximum Queue (m)	10.6	1.9	1.8
Average Queue (m)	6.8	0.1	0.1
95th Queue (m)	13.2	1.4	1.3
Link Distance (m)	145.1	73.3	164.0
Upstream Blk Time (%)			
Queuing Penalty (veh)			
Storage Bay Dist (m)			
Storage Blk Time (%)			
Queuing Penalty (veh)			

**Intersection: 17: rue Sucrierie & Richardson**

Movement	WB	NB	SB
Directions Served	LTR	LT	TR
Maximum Queue (m)	15.3	12.1	9.1
Average Queue (m)	8.5	6.1	1.0
95th Queue (m)	14.5	13.5	5.7
Link Distance (m)	95.4	72.4	82.8
Upstream Blk Time (%)			
Queuing Penalty (veh)			
Storage Bay Dist (m)			
Storage Blk Time (%)			
Queuing Penalty (veh)			

**Intersection: 18: Richardson & Montmorency**

Movement	WB	NB	SB
Directions Served	LTR	LT	TR
Maximum Queue (m)	11.9	10.5	9.2
Average Queue (m)	4.4	4.5	2.0
95th Queue (m)	12.2	12.0	8.2
Link Distance (m)	197.3	72.2	35.2
Upstream Blk Time (%)			
Queuing Penalty (veh)			
Storage Bay Dist (m)			
Storage Blk Time (%)			
Queuing Penalty (veh)			

Intersection: 19: rue de la Prairie & Rue Centre

Movement	EB	WB
Directions Served	LTR	LTR
Maximum Queue (m)	30.7	21.0
Average Queue (m)	12.1	6.9
95th Queue (m)	25.1	18.1
Link Distance (m)	127.6	127.0
Upstream Blk Time (%)		
Queuing Penalty (veh)		
Storage Bay Dist (m)		
Storage Blk Time (%)		
Queuing Penalty (veh)		

Intersection: 20: Rue Bridge & Rue Wellington

Movement	EB	EB	NB	NB	NB	SB	SB	SB
Directions Served	T	TR	LT	TR	R	LT	T	R
Maximum Queue (m)	178.8	182.6	42.2	44.9	33.0	163.6	167.2	8.7
Average Queue (m)	147.1	156.2	24.6	25.1	12.9	85.4	85.9	3.5
95th Queue (m)	211.1	206.3	39.1	39.9	26.2	154.4	155.4	9.7
Link Distance (m)	172.8	172.8	694.3	694.3		165.7	165.7	
Upstream Blk Time (%)	28	35				1	1	
Queuing Penalty (veh)	83	103				6	8	
Storage Bay Dist (m)					60.0			0.1
Storage Blk Time (%)		81		0			48	2
Queuing Penalty (veh)		132		0			13	12

Intersection: 21: Rue Ropery & Rue Centre

Movement	EB	WB
Directions Served	LT	LT
Maximum Queue (m)	33.0	31.0
Average Queue (m)	15.3	15.0
95th Queue (m)	29.8	26.5
Link Distance (m)	216.8	127.6
Upstream Blk Time (%)		
Queuing Penalty (veh)		
Storage Bay Dist (m)		
Storage Blk Time (%)	11	0
Queuing Penalty (veh)	0	0



**Intersection: 23: Rue Island & Rue Centre**

Movement	EB	WB	NB
Directions Served	LT	TR	LTR
Maximum Queue (m)	51.5	27.9	19.7
Average Queue (m)	24.8	10.5	6.9
95th Queue (m)	42.4	21.5	17.1
Link Distance (m)	127.0	230.7	153.9
Upstream Blk Time (%)			
Queuing Penalty (veh)			
Storage Bay Dist (m)			
Storage Blk Time (%)			13
Queuing Penalty (veh)			1

**Intersection: 40:**

Movement
Directions Served
Maximum Queue (m)
Average Queue (m)
95th Queue (m)
Link Distance (m)
Upstream Blk Time (%)
Queuing Penalty (veh)
Storage Bay Dist (m)
Storage Blk Time (%)
Queuing Penalty (veh)

**Intersection: 45: St-Patrick/Rue Saint-Patrick**

Movement	EB	WB	NB	NB	SB	SB
Directions Served	LT	TR	LT	R	L	R
Maximum Queue (m)	66.6	46.7	12.1	12.6	7.1	7.1
Average Queue (m)	24.6	19.7	6.1	7.5	0.8	1.1
95th Queue (m)	48.3	34.8	13.5	16.6	4.8	5.8
Link Distance (m)	157.6	158.0			57.1	57.1
Upstream Blk Time (%)						
Queuing Penalty (veh)						
Storage Bay Dist (m)				10.0		
Storage Blk Time (%)			3	3		
Queuing Penalty (veh)			1	1		

**Network Summary**

Network wide Queuing Penalty: 640

# C

## Annexe C Détail de la génération





**Dossier :** L02373H

**Effectué par :** Eric Séguin, ing,RSP (OIQ: #5058700)

**Vérifié par :** Moustapha Seck, ing. (OIQ: #145630)

**Date :** 25-oct-22

**Projet :** Le Nordelec Article 89

<b>Total des déplacements</b>	<b>Total</b>	<b>Entrée</b>	<b>Sortie</b>
<b>Nouveaux déplacements :</b>	<b>714</b>	<b>615</b>	<b>99</b>
<b>Échange:</b>	95	79	16
<b>Transport en commun:</b>	545	466	79
<b>Transport actif:</b>	223	158	65
<b>Pass-by :</b>	0	0	0
<b>Diverted Link Trips :</b>	0	0	0

<b>Code :</b>	222
<b>Référence :</b>	Trip Generation Handbook 11th Edition
<b>Land Use :</b>	Multifamily Housing (High-Rise)
<b>Description :</b>	Résidentiel Îlot A
<b>Période :</b>	Pointe AM des rues adjacentes, une heure entre 7h00 et 9h00

<b>Quantité</b>	<b>Unités</b>	<b>Taux de génération</b>	<b>Pourcentage entrée</b>	<b>Pourcentage sortie</b>
191	Unités	0.27	34%	66%
<b>Déplacements</b>	<b>Proportion</b>	<b>Total</b>	<b>Entrée</b>	<b>Sortie</b>
Génération brute	100%	52	18	34
Échange	6.0%	3	1	2
TC (en entrée)	14%	2	2	
TC (en sortie)	38%	13		13
TA (en entrée)	31%	5	5	
TA (en sortie)	24%	8		8
Pass-By	0%	0	0	0
Diverted Link Trips	0%	0	0	0
Net	40%	21	10	11

<b>Code :</b>	710
<b>Référence :</b>	Trip Generation Handbook 11th Edition
<b>Land Use :</b>	General Office Building
<b>Description :</b>	Bureaux Îlot A
<b>Période :</b>	Pointe AM des rues adjacentes, une heure entre 7h00 et 9h00

<b>Quantité</b>	<b>Unités</b>	<b>Taux de génération</b>	<b>Pourcentage entrée</b>	<b>Pourcentage sortie</b>
61	x1000 pi <sup>2</sup>	1.52	88%	12%
<b>Déplacements</b>	<b>Proportion</b>	<b>Total</b>	<b>Entrée</b>	<b>Sortie</b>
Génération brute	100%	93	82	11
Échange	6%	6	5	1
TC (en entrée)	40%	31	31	
TC (en sortie)	38%	4		4
TA (en entrée)	11%	9	9	
TA (en sortie)	24%	3		3
Pass-By	0%	0	0	0
Diverted Link Trips	0%	0	0	0
Net	43%	40	37	3



**Dossier :** L02373H  
**Effectué par :** Eric Séguin, ing,RSP (OIQ: #5058700)  
**Vérfié par :** Moustapha Seck, ing. (OIQ: #145630)  
**Date :** 25-oct-22

**Projet :** Le Nordelec Article 89

<b>Code :</b>	850			
<b>Référence :</b>	Trip Generation Handbook 11th Edition			
<b>Land Use :</b>	Supermarket			
<b>Description :</b>	Supermarché de quartier Îlot B - Phase 2B			
<b>Période :</b>	Pointe AM des rues adjacentes, une heure entre 7h00 et 9h00			
<b>Quantité</b>	<b>Unités</b>	<b>Taux de génération</b>	<b>Pourcentage entrée</b>	<b>Pourcentage sortie</b>
27.4	x1000 pi <sup>2</sup>	2.86	60%	40%
<b>Déplacements</b>	<b>Proportion</b>	<b>Total</b>	<b>Entrée</b>	<b>Sortie</b>
Génération brute	100%	78	47	31
Échange	6%	5	3	2
TC (en entrée)	13%	5	5	
TC (en sortie)	13%	4		4
TA (en entrée)	33%	14	14	
TA (en sortie)	33%	10		10
Pass-By	0%	0	0	0
Diverted Link Trips	0%	0	0	0
Net	51%	40	25	15



**Dossier :** L02373H  
**Effectué par :** Eric Séguin, ing,RSP (OIQ: #5058700)  
**Vérifié par :** Moustapha Seck, ing. (OIQ: #145630)  
**Date :** 25-oct-22

**Projet :** Le Nordelec Article 89

<b>Code :</b>	822			
<b>Référence :</b>	Trip Generation Handbook 11th Edition			
<b>Land Use :</b>	Strip Retail Plaza (< 40kp <sup>2</sup> )			
<b>Description :</b>	Commerces locaux - îlot B Phase 1			
<b>Période :</b>	Pointe AM des rues adjacentes, une heure entre 7h00 et 9h00			
<b>Quantité</b>	<b>Unités</b>	<b>Taux de génération</b>	<b>Pourcentage entrée</b>	<b>Pourcentage sortie</b>
16.6	x1000 pi <sup>2</sup>	2.36	60%	40%
<b>Déplacements</b>	<b>Proportion</b>	<b>Total</b>	<b>Entrée</b>	<b>Sortie</b>
Génération brute	100%	39	23	16
Échange	6%	2	1	1
TC (en entrée)	13%	3	3	
TC (en sortie)	13%	2		2
TA (en entrée)	33%	7	7	
TA (en sortie)	33%	5		5
Pass-By	0%	0	0	0
Diverted Link Trips	0%	0	0	0
Net	51%	20	12	8

<b>Code :</b>	710			
<b>Référence :</b>	Trip Generation Handbook 11th Edition			
<b>Land Use :</b>	General Office Building			
<b>Description :</b>	Bureaux - îlot B Phase 1			
<b>Période :</b>	Pointe AM des rues adjacentes, une heure entre 7h00 et 9h00			
<b>Quantité</b>	<b>Unités</b>	<b>Taux de génération</b>	<b>Pourcentage entrée</b>	<b>Pourcentage sortie</b>
220.6	x1000 pi <sup>2</sup>	1.52	88%	12%
<b>Déplacements</b>	<b>Proportion</b>	<b>Total</b>	<b>Entrée</b>	<b>Sortie</b>
Génération brute	100%	335	295	40
Échange	6%	20	18	2
TC (en entrée)	40%	111	111	
TC (en sortie)	38%	14		14
TA (en entrée)	11%	31	31	
TA (en sortie)	24%	9		9
Pass-By	0%	0	0	0
Diverted Link Trips	0%	0	0	0
Net	45%	150	135	15



**Dossier :** L02373H  
**Effectué par :** Eric Séguin, ing,RSP (OIQ: #5058700)  
**Vérifié par :** Moustapha Seck, ing. (OIQ: #145630)  
**Date :** 25-oct-22

**Projet :** Le Nordelec Article 89

<b>Code :</b>	710			
<b>Référence :</b>	Trip Generation Handbook 11th Edition ▼			
<b>Land Use :</b>	General Office Building			
<b>Description :</b>	Bureaux - îlot B Phase 2A			
<b>Période :</b>	Pointe AM des rues adjacentes, une heure entre 7h00 et 9h00			
<b>Quantité</b>	<b>Unités</b>	<b>Taux de génération</b>	<b>Pourcentage entrée</b>	<b>Pourcentage sortie</b>
307.7	x1000 pi <sup>2</sup>	1.52	88%	12%
<b>Déplacements</b>	<b>Proportion</b>	<b>Total</b>	<b>Entrée</b>	<b>Sortie</b>
Génération brute	100%	468	412	56
Échange	6%	28	25	3
TC ( <i>en entrée</i> )	40%	155	155	
TC ( <i>en sortie</i> )	38%	20		20
TA ( <i>en entrée</i> )	11%	42	42	
TA ( <i>en sortie</i> )	24%	13		13
Pass-By	0%	0	0	0
Diverted Link Trips	0%	0	0	0
Net	45%	210	190	20



**Dossier :** L02373H

**Effectué par :** Eric Séguin, ing,RSP (OIQ: #5058700)

**Vérfié par :** Moustapha Seck, ing. (OIQ: #145630)

**Date :** 25-oct-22

**Projet :** Le Nordelec Article 89

<b>Code :</b>	710			
<b>Référence :</b>	Trip Generation Handbook 11th Edition			
<b>Land Use :</b>	General Office Building			
<b>Description :</b>	Bureaux - îlot B Phase 2B			
<b>Période :</b>	Pointe AM des rues adjacentes, une heure entre 7h00 et 9h00			
<b>Quantité</b>	<b>Unités</b>	<b>Taux de génération</b>	<b>Pourcentage entrée</b>	<b>Pourcentage sortie</b>
171.8	x1000 pi <sup>2</sup>	1.52	88%	12%
<b>Déplacements</b>	<b>Proportion</b>	<b>Total</b>	<b>Entrée</b>	<b>Sortie</b>
Génération brute	100%	261	230	31
Échange	6%	16	14	2
TC ( <i>en entrée</i> )	40%	86	86	
TC ( <i>en sortie</i> )	38%	11		11
TA ( <i>en entrée</i> )	11%	24	24	
TA ( <i>en sortie</i> )	24%	7		7
Pass-By	0%	0	0	0
Diverted Link Trips	0%	0	0	0
Net	45%	117	106	11

<b>Code :</b>	710			
<b>Référence :</b>	Trip Generation Handbook 11th Edition			
<b>Land Use :</b>	General Office Building			
<b>Description :</b>	Bureaux - îlot E			
<b>Période :</b>	Pointe AM des rues adjacentes, une heure entre 7h00 et 9h00			
<b>Quantité</b>	<b>Unités</b>	<b>Taux de génération</b>	<b>Pourcentage entrée</b>	<b>Pourcentage sortie</b>
142	x1000 pi <sup>2</sup>	1.52	88%	12%
<b>Déplacements</b>	<b>Proportion</b>	<b>Total</b>	<b>Entrée</b>	<b>Sortie</b>
Génération brute	100%	216	190	26
Échange	6%	13	11	2
TC ( <i>en entrée</i> )	40%	71	71	
TC ( <i>en sortie</i> )	38%	9		9
TA ( <i>en entrée</i> )	11%	19	19	
TA ( <i>en sortie</i> )	24%	6		6
Pass-By	0%	0	0	0
Diverted Link Trips	0%	0	0	0
Net	45%	98	89	9



**Dossier :** L02373H  
**Effectué par :** Eric Séguin, ing,RSP (OIQ: #5058700)  
**Vérifié par :** Moustapha Seck, ing. (OIQ: #145630)  
**Date :** 25-oct-22

**Projet :** Le Nordelec Article 89

<b>Code :</b>	822			
<b>Référence :</b>	Trip Generation Handbook 11th Edition			
<b>Land Use :</b>	Strip Retail Plaza (< 40kp <sup>2</sup> )			
<b>Description :</b>	Commerces îlot E			
<b>Période :</b>	Pointe AM des rues adjacentes, une heure entre 7h00 et 9h00			
<b>Quantité</b>	<b>Unités</b>	<b>Taux de génération</b>	<b>Pourcentage entrée</b>	<b>Pourcentage sortie</b>
15	x1000 pi <sup>2</sup>	2.36	60%	40%
<b>Déplacements</b>	<b>Proportion</b>	<b>Total</b>	<b>Entrée</b>	<b>Sortie</b>
Génération brute	100%	35	21	14
Échange	6%	2	1	1
TC ( <i>en entrée</i> )	13%	2	2	
TC ( <i>en sortie</i> )	13%	2		2
TA ( <i>en entrée</i> )	33%	7	7	
TA ( <i>en sortie</i> )	33%	4		4
Pass-By	0%	0	0	0
Diverted Link Trips	0%	0	0	0
Net	51%	18	11	7





**Dossier :** L02373H  
**Effectué par :** Eric Séguin, ing,RSP (OIQ: #5058700)  
**Vérfié par :** Moustapha Seck, ing. (OIQ: #145630)  
**Date :** 25-oct-22

**Projet :** Le Nordelec Article 89-HPPM

<b>Total des déplacements</b>	<b>Total</b>	<b>Entrée</b>	<b>Sortie</b>
<b>Nouveaux déplacements :</b>	<b>788</b>	<b>213</b>	<b>575</b>
<b>Échange:</b>	120	33	87
<b>Transport en commun:</b>	337	66	271
<b>Transport actif:</b>	542	157	385
<b>Pass-by :</b>	28	14	14
<b>Diverted Link Trips :</b>	0	0	0

<b>Code :</b>	222
<b>Référence :</b>	Trip Generation Handbook 11th Edition ▼
<b>Land Use :</b>	Multifamily Housing (High-Rise)
<b>Description :</b>	Résidentiel Îlot A
<b>Période :</b>	Pointe PM des rues adjacentes, une heure entre 16h00 et 18h00 ▼

<b>Quantité</b>	<b>Unités</b>	<b>Taux de génération</b>	<b>Pourcentage entrée</b>	<b>Pourcentage sortie</b>
191	Unités	0.32	56%	44%
<b>Déplacements</b>	<b>Proportion</b>	<b>Total</b>	<b>Entrée</b>	<b>Sortie</b>
Génération brute	100%	61	34	27
Échange	6.6%	4	2	2
TC ( <i>en entrée</i> )	39%	12	12	
TC ( <i>en sortie</i> )	25%	6		6
TA ( <i>en entrée</i> )	25%	8	8	
TA ( <i>en sortie</i> )	28%	7		7
Pass-By	0%	0	0	0
Diverted Link Trips	0%	0	0	0
<b>Net</b>	<b>39%</b>	<b>24</b>	<b>12</b>	<b>12</b>



<b>Dossier :</b>	L02373H
<b>Effectué par :</b>	Eric Séguin, ing,RSP (OIQ: #5058700)
<b>Véifié par :</b>	Moustapha Seck, ing. (OIQ: #145630)
<b>Date :</b>	25-oct-22

**Projet :** Le Nordelec Article 89-HPPM

<b>Code :</b>	710			
<b>Référence :</b>	Trip Generation Handbook 11th Edition ▼			
<b>Land Use :</b>	General Office Building			
<b>Description :</b>	Bureaux Îlot A			
<b>Période :</b>	Pointe PM des rues adjacentes, une heure entre 16h00 et 18h00			
<b>Quantité</b>	<b>Unités</b>	<b>Taux de génération</b>	<b>Pourcentage entrée</b>	<b>Pourcentage sortie</b>
61	x1000 pi²	1.44	17%	83%
<b>Déplacements</b>	<b>Proportion</b>	<b>Total</b>	<b>Entrée</b>	<b>Sortie</b>
Génération brute	100%	88	15	73
Échange	7%	6	1	5
TC ( <i>en entrée</i> )	20%	3	3	
TC ( <i>en sortie</i> )	25%	17		17
TA ( <i>en entrée</i> )	25%	4	4	
TA ( <i>en sortie</i> )	28%	19		19
Pass-By	0%	0	0	0
Diverted Link Trips	0%	0	0	0
Net	44%	39	7	32

<b>Code :</b>	850			
<b>Référence :</b>	Trip Generation Handbook 11th Edition ▼			
<b>Land Use :</b>	Supermarket			
<b>Description :</b>	Supermarché de quartier Îlot B - Phase 2B			
<b>Période :</b>	Pointe PM des rues adjacentes, une heure entre 16h00 et 18h00			
<b>Quantité</b>	<b>Unités</b>	<b>Taux de génération</b>	<b>Pourcentage entrée</b>	<b>Pourcentage sortie</b>
27.4	x1000 pi²	8.95	50%	50%
<b>Déplacements</b>	<b>Proportion</b>	<b>Total</b>	<b>Entrée</b>	<b>Sortie</b>
Génération brute	100%	245	123	122
Échange	7%	16	8	8
TC ( <i>en entrée</i> )	6%	7	7	
TC ( <i>en sortie</i> )	6%	7		7
TA ( <i>en entrée</i> )	45%	52	52	
TA ( <i>en sortie</i> )	45%	52		52
Pass-By	25%	28	14	14
Diverted Link Trips	0%	0	0	0
Net	34%	83	42	41



<b>Dossier :</b>	L02373H
<b>Effectué par :</b>	Eric Séguin, ing,RSP (OIQ: #5058700)
<b>Vérfié par :</b>	Moustapha Seck, ing. (OIQ: #145630)
<b>Date :</b>	25-oct-22

**Projet :** Le Nordelec Article 89-HPPM

<b>Code :</b>	822			
<b>Référence :</b>	Trip Generation Handbook 11th Edition ▼			
<b>Land Use :</b>	Strip Retail Plaza (< 40kpi²)			
<b>Description :</b>	Commerces locaux - Îlot B Phase 1			
<b>Période :</b>	Pointe PM des rues adjacentes, une heure entre 16h00 et 18h00			
<b>Quantité</b>	<b>Unités</b>	<b>Taux de génération</b>	<b>Pourcentage entrée</b>	<b>Pourcentage sortie</b>
16.6	x1000 pi²	6.59	50%	50%
<b>Déplacements</b>	<b>Proportion</b>	<b>Total</b>	<b>Entrée</b>	<b>Sortie</b>
Génération brute	100%	109	55	54
Échange	7%	7	4	3
TC ( <i>en entrée</i> )	6%	3	3	
TC ( <i>en sortie</i> )	6%	3		3
TA ( <i>en entrée</i> )	45%	23	23	
TA ( <i>en sortie</i> )	45%	23		23
Pass-By	0%	0	0	0
Diverted Link Trips	0%	0	0	0
Net	46%	50	25	25

<b>Code :</b>	710			
<b>Référence :</b>	Trip Generation Handbook 11th Edition ▼			
<b>Land Use :</b>	General Office Building			
<b>Description :</b>	Bureaux - îlot B Phase 1			
<b>Période :</b>	Pointe PM des rues adjacentes, une heure entre 16h00 et 18h00			
<b>Quantité</b>	<b>Unités</b>	<b>Taux de génération</b>	<b>Pourcentage entrée</b>	<b>Pourcentage sortie</b>
220.6	x1000 pi²	1.44	17%	83%
<b>Déplacements</b>	<b>Proportion</b>	<b>Total</b>	<b>Entrée</b>	<b>Sortie</b>
Génération brute	100%	318	54	264
Échange	7%	21	4	17
TC ( <i>en entrée</i> )	20%	10	10	
TC ( <i>en sortie</i> )	25%	61		61
TA ( <i>en entrée</i> )	25%	13	13	
TA ( <i>en sortie</i> )	28%	69		69
Pass-By	0%	0	0	0
Diverted Link Trips	0%	0	0	0
Net	45%	144	27	117



<b>Dossier :</b>	L02373H
<b>Effectué par :</b>	Eric Séguin, ing,RSP (OIQ: #5058700)
<b>Vérfié par :</b>	Moustapha Seck, ing. (OIQ: #145630)
<b>Date :</b>	25-oct-22

**Projet :** Le Nordelec Article 89-HPPM

<b>Code :</b>	710			
<b>Référence :</b>	Trip Generation Handbook 11th Edition			
<b>Land Use :</b>	General Office Building			
<b>Description :</b>	Bureaux - îlot B Phase 2A			
<b>Période :</b>	Pointe PM des rues adjacentes, une heure entre 16h00 et 18h00			
<b>Quantité</b>	<b>Unités</b>	<b>Taux de génération</b>	<b>Pourcentage entrée</b>	<b>Pourcentage sortie</b>
307.7	x1000 pi <sup>2</sup>	1.44	17%	83%
<b>Déplacements</b>	<b>Proportion</b>	<b>Total</b>	<b>Entrée</b>	<b>Sortie</b>
Génération brute	100%	443	75	368
Échange	7%	29	5	24
TC ( <i>en entrée</i> )	20%	14	14	
TC ( <i>en sortie</i> )	25%	86		86
TA ( <i>en entrée</i> )	25%	18	18	
TA ( <i>en sortie</i> )	28%	96		96
Pass-By	0%	0	0	0
Diverted Link Trips	0%	0	0	0
Net	45%	200	38	162

<b>Code :</b>	710			
<b>Référence :</b>	Trip Generation Handbook 11th Edition			
<b>Land Use :</b>	General Office Building			
<b>Description :</b>	Bureaux - îlot B Phase 2B			
<b>Période :</b>	Pointe PM des rues adjacentes, une heure entre 16h00 et 18h00			
<b>Quantité</b>	<b>Unités</b>	<b>Taux de génération</b>	<b>Pourcentage entrée</b>	<b>Pourcentage sortie</b>
171.8	x1000 pi <sup>2</sup>	1.44	17%	83%
<b>Déplacements</b>	<b>Proportion</b>	<b>Total</b>	<b>Entrée</b>	<b>Sortie</b>
Génération brute	100%	247	42	205
Échange	7%	16	3	13
TC ( <i>en entrée</i> )	20%	8	8	
TC ( <i>en sortie</i> )	25%	48		48
TA ( <i>en entrée</i> )	25%	10	10	
TA ( <i>en sortie</i> )	28%	54		54
Pass-By	0%	0	0	0
Diverted Link Trips	0%	0	0	0
Net	45%	111	21	90



<b>Dossier :</b>	L02373H
<b>Effectué par :</b>	Eric Séguin, ing,RSP (OIQ: #5058700)
<b>Vérfié par :</b>	Moustapha Seck, ing. (OIQ: #145630)
<b>Date :</b>	25-oct-22

**Projet :** Le Nordelec Article 89-HPPM

<b>Code :</b>	710			
<b>Référence :</b>	Trip Generation Handbook 11th Edition ▼			
<b>Land Use :</b>	General Office Building			
<b>Description :</b>	Bureaux - îlot E			
<b>Période :</b>	Pointe PM des rues adjacentes, une heure entre 16h00 et 18h00			
<b>Quantité</b>	<b>Unités</b>	<b>Taux de génération</b>	<b>Pourcentage entrée</b>	<b>Pourcentage sortie</b>
142	x1000 pi²	1.44	17%	83%
<b>Déplacements</b>	<b>Proportion</b>	<b>Total</b>	<b>Entrée</b>	<b>Sortie</b>
Génération brute	100%	205	35	170
Échange	7%	14	2	12
TC ( <i>en entrée</i> )	20%	6	6	
TC ( <i>en sortie</i> )	25%	40		40
TA ( <i>en entrée</i> )	25%	8	8	
TA ( <i>en sortie</i> )	28%	44		44
Pass-By	0%	0	0	0
Diverted Link Trips	0%	0	0	0
Net	45%	93	19	74

<b>Code :</b>	822			
<b>Référence :</b>	Trip Generation Handbook 11th Edition ▼			
<b>Land Use :</b>	Strip Retail Plaza (< 40kpi²)			
<b>Description :</b>	Commerces îlot E			
<b>Période :</b>	Pointe PM des rues adjacentes, une heure entre 16h00 et 18h00			
<b>Quantité</b>	<b>Unités</b>	<b>Taux de génération</b>	<b>Pourcentage entrée</b>	<b>Pourcentage sortie</b>
15	x1000 pi²	6.59	50%	50%
<b>Déplacements</b>	<b>Proportion</b>	<b>Total</b>	<b>Entrée</b>	<b>Sortie</b>
Génération brute	100%	99	50	49
Échange	7%	7	4	3
TC ( <i>en entrée</i> )	6%	3	3	
TC ( <i>en sortie</i> )	6%	3		3
TA ( <i>en entrée</i> )	45%	21	21	
TA ( <i>en sortie</i> )	45%	21		21
Pass-By	0%	0	0	0
Diverted Link Trips	0%	0	0	0
Net	44%	44	22	22





# D

## Annexe D Détail des simulations anticipées





**1: rue St-Patrick & rue Charlevoix Performance by approach**

Approach	EB	WB	NB	SB	All
Denied Delay (hr)	0.2	0.0	0.3	0.0	0.5
Denied Del/Veh (s)	0.8	0.1	2.7	0.2	1.0
Total Delay (hr)	18.8	1.1	8.0	1.7	29.6
Total Del/Veh (s)	88.2	11.0	76.0	31.5	63.0
Vehicles Entered	735	340	369	195	1639
Vehicles Exited	734	339	370	195	1638
Hourly Exit Rate	734	339	370	195	1638
Input Volume	727	349	384	200	1660
% of Volume	101	97	96	98	99

**2: des Seigneurs & St-Patrick Performance by approach**

Approach	EB	WB	NB	SB	All
Denied Delay (hr)	0.5	0.1	0.0	0.0	0.6
Denied Del/Veh (s)	2.9	0.4	0.1	1.0	1.5
Total Delay (hr)	10.8	4.9	0.0	1.4	17.1
Total Del/Veh (s)	64.0	27.1	16.6	29.0	43.0
Vehicles Entered	600	644	3	170	1417
Vehicles Exited	592	642	3	168	1405
Hourly Exit Rate	592	642	3	168	1405
Input Volume	602	659	2	169	1432
% of Volume	98	97	150	99	98

**3: Shearer/Accès & St-Patrick Performance by approach**

Approach	EB	WB	NB	SB	All
Denied Delay (hr)	0.0	0.0	0.0	0.0	0.0
Denied Del/Veh (s)	0.0	0.1	0.3	0.1	0.1
Total Delay (hr)	0.2	0.7	0.5	0.0	1.4
Total Del/Veh (s)	1.2	4.1	19.0	14.4	3.9
Vehicles Entered	581	589	99	1	1270
Vehicles Exited	580	592	99	1	1272
Hourly Exit Rate	580	592	99	1	1272
Input Volume	583	609	99	1	1292
% of Volume	99	97	100	100	98

**4: St-Patrick Performance by approach**

Approach	EB	WB	NB	All
Denied Delay (hr)	0.0	0.0	0.0	0.0
Denied Del/Veh (s)	0.1	0.1	0.0	0.1
Total Delay (hr)	0.2	0.4	0.5	1.2
Total Del/Veh (s)	1.3	2.7	13.5	3.1
Vehicles Entered	629	586	128	1343
Vehicles Exited	629	588	128	1345
Hourly Exit Rate	629	588	128	1345
Input Volume	630	615	125	1370
% of Volume	100	96	102	98

**5: Montmorency & St-Patrick Performance by approach**

Approach	EB	WB	NB	SB	All
Denied Delay (hr)	0.1	6.7	0.0	0.0	6.8
Denied Del/Veh (s)	0.3	32.3	0.4	0.1	16.0
Total Delay (hr)	1.3	14.3	1.0	0.1	16.6
Total Del/Veh (s)	6.8	68.5	35.9	32.9	39.1
Vehicles Entered	664	733	100	12	1509
Vehicles Exited	664	729	100	12	1505
Hourly Exit Rate	664	729	100	12	1505
Input Volume	666	766	93	12	1537
% of Volume	100	95	108	100	98

**6: Rue Bridge & Rue Saint-Patrick Performance by approach**

Approach	EB	WB	NB	All
Denied Delay (hr)	0.0	0.3	0.0	0.3
Denied Del/Veh (s)	0.0	3.3	0.2	1.0
Total Delay (hr)	1.9	5.7	3.4	10.9
Total Del/Veh (s)	19.3	64.1	25.5	34.3
Vehicles Entered	349	314	471	1134
Vehicles Exited	349	311	463	1123
Hourly Exit Rate	349	311	463	1123
Input Volume	349	325	463	1137
% of Volume	100	96	100	99

**7: Rue Wellington & Rue Saint-Patrick Performance by approach**

Approach	EB	NB	SB	All
Denied Delay (hr)	0.0	0.0	0.3	0.3
Denied Del/Veh (s)	0.1	0.0	1.8	0.5
Total Delay (hr)	5.4	2.9	2.4	10.7
Total Del/Veh (s)	76.0	7.9	14.5	17.7
Vehicles Entered	251	1313	580	2144
Vehicles Exited	250	1313	583	2146
Hourly Exit Rate	250	1313	583	2146
Input Volume	255	1311	585	2151
% of Volume	98	100	100	100

**8: rue Charlevoix & Rue Centre Performance by approach**

Approach	EB	WB	NB	SB	All
Denied Delay (hr)	0.0	0.0	0.0	0.0	0.1
Denied Del/Veh (s)	0.4	0.0	0.2	0.0	0.2
Total Delay (hr)	1.7	0.5	1.0	0.5	3.6
Total Del/Veh (s)	16.5	17.6	14.0	14.2	15.5
Vehicles Entered	354	109	252	120	835
Vehicles Exited	357	108	252	120	837
Hourly Exit Rate	357	108	252	120	837
Input Volume	353	111	254	127	845
% of Volume	101	97	99	94	99

**9: rue Sucrierie Performance by approach**

Approach	EB	NB	SB	All
Denied Delay (hr)	0.0	0.0	0.0	0.0
Denied Del/Veh (s)	0.0	0.0	0.0	0.0
Total Delay (hr)	0.0	0.1	0.0	0.2
Total Del/Veh (s)	3.8	2.3	0.4	2.0
Vehicles Entered	46	149	81	276
Vehicles Exited	47	149	81	277
Hourly Exit Rate	47	149	81	277
Input Volume	46	151	86	283
% of Volume	102	99	94	98

**10: Montmorency Performance by approach**

Approach	EB	NB	SB	All
Denied Delay (hr)	0.0	0.0	0.0	0.0
Denied Del/Veh (s)	0.1	0.0	0.0	0.0
Total Delay (hr)	0.1	0.0	0.1	0.1
Total Del/Veh (s)	7.7	0.9	0.5	0.8
Vehicles Entered	27	66	530	623
Vehicles Exited	27	66	529	622
Hourly Exit Rate	27	66	529	622
Input Volume	28	59	536	623
% of Volume	96	112	99	100

**11: Montmorency Performance by approach**

Approach	EB	NB	SB	All
Denied Delay (hr)	0.0	0.0	0.0	0.0
Denied Del/Veh (s)	0.2	0.1	0.0	0.0
Total Delay (hr)	0.1	0.2	0.1	0.3
Total Del/Veh (s)	4.9	4.5	0.9	2.2
Vehicles Entered	58	131	371	560
Vehicles Exited	58	131	371	560
Hourly Exit Rate	58	131	371	560
Input Volume	55	126	369	550
% of Volume	105	104	101	102

**12: Shearer & Centre Performance by approach**

Approach	EB	WB	NB	SB	All
Denied Delay (hr)	0.0	0.0	0.0	0.0	0.0
Denied Del/Veh (s)	0.0	0.0	0.1	0.1	0.0
Total Delay (hr)	0.2	0.2	0.2	0.6	1.2
Total Del/Veh (s)	5.1	4.7	12.2	14.6	8.6
Vehicles Entered	168	124	51	152	495
Vehicles Exited	169	123	52	151	495
Hourly Exit Rate	169	123	52	151	495
Input Volume	159	131	51	150	491
% of Volume	106	94	102	101	101

**13: rue Sucrierie & Centre Performance by approach**

Approach	EB	WB	NB	SB	All
Denied Delay (hr)	0.0	0.0	0.0	0.0	0.0
Denied Del/Veh (s)	0.0	0.0	0.1	0.0	0.0
Total Delay (hr)	1.0	0.7	0.2	0.0	1.9
Total Del/Veh (s)	18.8	10.4	10.5	5.0	13.5
Vehicles Entered	192	247	55	10	504
Vehicles Exited	191	246	56	10	503
Hourly Exit Rate	191	246	56	10	503
Input Volume	185	252	54	9	500
% of Volume	103	98	104	111	101

**14: rue Centre/Centre Performance by approach**

Approach	EB	WB	SB	All
Denied Delay (hr)	0.0	0.0	0.0	0.0
Denied Del/Veh (s)	0.0	0.1	0.0	0.1
Total Delay (hr)	0.1	0.1	0.0	0.2
Total Del/Veh (s)	2.1	0.4	6.6	1.0
Vehicles Entered	156	568	27	751
Vehicles Exited	155	570	27	752
Hourly Exit Rate	155	570	27	752
Input Volume	148	571	27	746
% of Volume	105	100	100	101

**15: Rue Wellington & rue Centre/accès Performance by approach**

Approach	EB	WB	NB	SB	All
Denied Delay (hr)	0.0	0.0	0.0	0.0	0.0
Denied Del/Veh (s)	0.0	0.1	0.0	0.3	0.2
Total Delay (hr)	0.6	0.2	0.3	1.2	2.3
Total Del/Veh (s)	18.3	36.9	3.6	7.0	7.9
Vehicles Entered	125	17	292	618	1052
Vehicles Exited	124	17	292	619	1052
Hourly Exit Rate	124	17	292	619	1052
Input Volume	124	17	290	608	1039
% of Volume	100	100	101	102	101

**16: Shearer & Richardson Performance by approach**

Approach	WB	NB	SB	All
Denied Delay (hr)	0.0	0.0	0.0	0.0
Denied Del/Veh (s)	0.0	0.0	0.0	0.0
Total Delay (hr)	0.2	0.0	0.0	0.2
Total Del/Veh (s)	6.3	0.9	0.3	3.6
Vehicles Entered	121	72	37	230
Vehicles Exited	122	73	37	232
Hourly Exit Rate	122	73	37	232
Input Volume	114	70	43	227
% of Volume	107	104	86	102

**17: rue Sucrierie & Richardson Performance by approach**

Approach	WB	NB	SB	All
Denied Delay (hr)	0.0	0.0	0.0	0.0
Denied Del/Veh (s)	0.0	0.0	0.0	0.0
Total Delay (hr)	0.2	0.2	0.0	0.4
Total Del/Veh (s)	5.4	4.7	2.7	4.9
Vehicles Entered	118	163	5	286
Vehicles Exited	119	163	5	287
Hourly Exit Rate	119	163	5	287
Input Volume	109	164	4	277
% of Volume	109	99	125	104

**18: Richardson & Montmorency Performance by approach**

Approach	WB	NB	SB	All
Denied Delay (hr)	0.0	0.0	0.0	0.0
Denied Del/Veh (s)	0.2	0.0	0.0	0.0
Total Delay (hr)	0.1	0.2	0.1	0.3
Total Del/Veh (s)	4.6	4.7	2.9	4.0
Vehicles Entered	44	126	89	259
Vehicles Exited	44	126	89	259
Hourly Exit Rate	44	126	89	259
Input Volume	41	121	88	250
% of Volume	107	104	101	104

**19: rue de la Prairie & Rue Centre Performance by approach**

Approach	EB	WB	NB	SB	All
Denied Delay (hr)	0.0	0.0	0.0	0.0	0.0
Denied Del/Veh (s)	0.0	0.0	0.1	0.1	0.0
Total Delay (hr)	0.7	0.1	0.1	0.1	0.9
Total Del/Veh (s)	8.6	5.2	10.6	9.6	8.3
Vehicles Entered	273	53	24	28	378
Vehicles Exited	273	53	24	28	378
Hourly Exit Rate	273	53	24	28	378
Input Volume	267	54	24	25	370
% of Volume	102	98	100	112	102

**20: Rue Bridge & Rue Wellington Performance by approach**

Approach	EB	WB	NB	SB	All
Denied Delay (hr)	0.0	0.0	0.2	0.0	0.2
Denied Del/Veh (s)	0.0	0.3	0.5	0.0	0.4
Total Delay (hr)	4.8	6.1	17.2	0.7	28.8
Total Del/Veh (s)	41.0	66.8	40.4	37.2	44.1
Vehicles Entered	414	324	1505	66	2309
Vehicles Exited	416	325	1495	67	2303
Hourly Exit Rate	416	325	1495	67	2303
Input Volume	412	321	1485	69	2287
% of Volume	101	101	101	97	101

**21: Rue Ropery & Rue Centre Performance by approach**

Approach	EB	WB	SB	All
Denied Delay (hr)	0.0	0.0	0.0	0.0
Denied Del/Veh (s)	0.0	0.0	0.1	0.0
Total Delay (hr)	0.6	0.3	0.0	0.9
Total Del/Veh (s)	7.8	10.6	11.2	8.6
Vehicles Entered	269	108	7	384
Vehicles Exited	269	107	7	383
Hourly Exit Rate	269	107	7	383
Input Volume	262	106	9	377
% of Volume	103	101	78	102

**23: Rue Island & Rue Centre Performance by approach**

Approach	EB	WB	NB	All
Denied Delay (hr)	0.0	0.0	0.0	0.0
Denied Del/Veh (s)	0.0	0.0	0.1	0.0
Total Delay (hr)	0.8	0.2	0.2	1.2
Total Del/Veh (s)	16.9	4.7	12.4	12.2
Vehicles Entered	177	114	61	352
Vehicles Exited	177	115	61	353
Hourly Exit Rate	177	115	61	353
Input Volume	169	127	60	356
% of Volume	105	91	102	99

**38: Performance by approach**

Approach	EB	WB	NE	All
Denied Delay (hr)	0.0	0.0	0.0	0.0
Denied Del/Veh (s)	0.1	0.0	0.1	0.0
Total Delay (hr)	0.0	0.0	0.0	0.0
Total Del/Veh (s)	0.6	0.5	0.0	0.4
Vehicles Entered	28	144	18	190
Vehicles Exited	28	144	18	190
Hourly Exit Rate	28	144	18	190
Input Volume	28	153	17	198
% of Volume	100	94	106	96

**40: Performance by approach**

Approach	NB	All
Denied Delay (hr)	0.0	0.0
Denied Del/Veh (s)	0.0	0.0
Total Delay (hr)	0.0	0.0
Total Del/Veh (s)	0.8	0.8
Vehicles Entered	75	75
Vehicles Exited	75	75
Hourly Exit Rate	75	75
Input Volume	78	78
% of Volume	96	96



45: St-Patrick/Rue Saint-Patrick Performance by approach

Approach	EB	WB	NB	All
Denied Delay (hr)	1.8	0.0	0.0	1.8
Denied Del/Veh (s)	10.8	0.0	0.8	6.6
Total Delay (hr)	6.7	0.8	0.2	7.6
Total Del/Veh (s)	40.2	9.5	7.8	27.8
Vehicles Entered	591	291	101	983
Vehicles Exited	583	292	101	976
Hourly Exit Rate	583	292	101	976
Input Volume	589	297	103	989
% of Volume	99	98	98	99

Total Network Performance

Denied Delay (hr)	10.7
Denied Del/Veh (s)	6.7
Total Delay (hr)	142.1
Total Del/Veh (s)	85.0
Vehicles Entered	5751
Vehicles Exited	5713
Hourly Exit Rate	5713
Input Volume	26948
% of Volume	21

**Intersection: 1: rue St-Patrick & rue Charlevoix**

Movement	EB	EB	WB	WB	NB	SB
Directions Served	LT	R	LT	R	LTR	LTR
Maximum Queue (m)	360.6	37.5	47.0	37.2	163.2	74.1
Average Queue (m)	205.9	9.2	20.9	12.3	93.8	33.4
95th Queue (m)	414.2	34.4	43.1	30.2	155.0	59.2
Link Distance (m)	519.1		365.4		213.7	892.0
Upstream Blk Time (%)						
Queuing Penalty (veh)						
Storage Bay Dist (m)		30.0		30.0		
Storage Blk Time (%)	54	0	3	0	74	52
Queuing Penalty (veh)	12	1	3	1	8	20

**Intersection: 2: des Seigneurs & St-Patrick**

Movement	EB	EB	WB	WB	NB	SB	SB
Directions Served	LT	TR	LT	R	LTR	LT	R
Maximum Queue (m)	164.3	37.5	66.8	71.6	7.2	71.5	18.0
Average Queue (m)	122.3	11.9	36.0	51.8	0.5	27.2	6.7
95th Queue (m)	201.1	39.3	60.9	77.6	3.8	53.7	17.3
Link Distance (m)	159.4		57.6	57.6	57.0	286.2	
Upstream Blk Time (%)	14		2	11			
Queuing Penalty (veh)	82		5	36			
Storage Bay Dist (m)		30.0					5.0
Storage Blk Time (%)	55	0				51	6
Queuing Penalty (veh)	123	0				18	8

**Intersection: 3: Shearer/accès & St-Patrick**

Movement	EB	EB	WB	NB	NB	SB
Directions Served	LT	R	LTR	LT	R	LTR
Maximum Queue (m)	24.6	3.2	80.5	32.3	22.2	3.4
Average Queue (m)	2.0	0.1	16.2	10.6	8.4	0.1
95th Queue (m)	12.8	1.7	54.4	24.3	20.1	1.8
Link Distance (m)	57.6	57.6	141.4	164.9		88.0
Upstream Blk Time (%)						
Queuing Penalty (veh)						
Storage Bay Dist (m)					15.0	
Storage Blk Time (%)				11	1	
Queuing Penalty (veh)				5	1	

**Intersection: 4: St-Patrick**

Movement	EB	WB	NB
Directions Served	TR	LT	LR
Maximum Queue (m)	4.3	49.6	37.6
Average Queue (m)	0.3	10.3	14.8
95th Queue (m)	3.0	33.6	27.2
Link Distance (m)	141.4	93.8	72.7
Upstream Blk Time (%)			
Queuing Penalty (veh)			
Storage Bay Dist (m)			
Storage Blk Time (%)			
Queuing Penalty (veh)			

**Intersection: 5: Montmorency & St-Patrick**

Movement	EB	EB	WB	NB	NB	SB
Directions Served	T	R	LTR	LT	R	LTR
Maximum Queue (m)	85.9	22.5	201.0	28.3	24.6	12.6
Average Queue (m)	34.1	18.0	162.6	12.5	11.4	2.8
95th Queue (m)	74.9	27.8	245.2	25.4	22.9	9.5
Link Distance (m)	93.8		197.5	26.2	26.2	55.1
Upstream Blk Time (%)	0		8	1	1	
Queuing Penalty (veh)	0		57	1	0	
Storage Bay Dist (m)		15.0				
Storage Blk Time (%)	7	13	57			10
Queuing Penalty (veh)	24	39	1			0

**Intersection: 6: Rue Bridge & Rue Saint-Patrick**

Movement	EB	EB	WB	WB	NB	NB
Directions Served	T	R	L	T	L	TR
Maximum Queue (m)	70.7	15.7	50.1	124.3	132.1	36.4
Average Queue (m)	37.3	3.0	2.1	66.0	48.0	2.3
95th Queue (m)	63.3	11.1	33.6	144.6	125.3	29.8
Link Distance (m)	197.5	197.5	225.8	225.8	148.6	148.6
Upstream Blk Time (%)			0	3	1	0
Queuing Penalty (veh)			0	4	2	0
Storage Bay Dist (m)						
Storage Blk Time (%)						
Queuing Penalty (veh)						

**Intersection: 7: Rue Wellington & Rue Saint-Patrick**

Movement	EB	NB	NB	SB	SB	SB
Directions Served	L	LT	T	T	T	R
Maximum Queue (m)	91.7	92.5	96.2	81.7	100.7	9.3
Average Queue (m)	52.6	41.0	45.5	17.1	47.5	8.9
95th Queue (m)	81.4	75.0	77.6	57.9	85.8	9.5
Link Distance (m)	225.8	167.6	167.6	261.8	261.8	
Upstream Blk Time (%)						
Queuing Penalty (veh)						
Storage Bay Dist (m)						0.1
Storage Blk Time (%)					0	0
Queuing Penalty (veh)					0	0

**Intersection: 8: rue Charlevoix & Rue Centre**

Movement	EB	WB	NB	SB
Directions Served	LTR	LTR	LTR	LTR
Maximum Queue (m)	75.7	35.6	47.6	40.6
Average Queue (m)	40.0	16.1	25.2	16.2
95th Queue (m)	66.6	30.0	42.0	33.0
Link Distance (m)	180.1	218.4	404.2	213.7
Upstream Blk Time (%)				
Queuing Penalty (veh)				
Storage Bay Dist (m)				
Storage Blk Time (%)	46	27		
Queuing Penalty (veh)	8	5		

**Intersection: 9: rue Sucrierie**

Movement	EB	NB	SB
Directions Served	LR	LT	TR
Maximum Queue (m)	12.1	12.9	4.0
Average Queue (m)	7.5	2.4	0.1
95th Queue (m)	13.3	9.6	1.4
Link Distance (m)	26.6	83.1	72.7
Upstream Blk Time (%)			
Queuing Penalty (veh)			
Storage Bay Dist (m)			
Storage Blk Time (%)			
Queuing Penalty (veh)			

**Intersection: 10: Montmorency**

Movement	EB	NB
Directions Served	LR	LT
Maximum Queue (m)	14.0	1.8
Average Queue (m)	4.5	0.1
95th Queue (m)	10.7	1.3
Link Distance (m)	35.6	79.8
Upstream Blk Time (%)		
Queuing Penalty (veh)		
Storage Bay Dist (m)		
Storage Blk Time (%)		
Queuing Penalty (veh)		

**Intersection: 11: Montmorency**

Movement	EB	NB	SB
Directions Served	LR	LT	TR
Maximum Queue (m)	21.9	24.0	10.1
Average Queue (m)	8.9	9.9	1.3
95th Queue (m)	17.3	20.4	6.1
Link Distance (m)	27.0	35.8	79.8
Upstream Blk Time (%)	0	0	
Queuing Penalty (veh)	0	0	
Storage Bay Dist (m)			
Storage Blk Time (%)			
Queuing Penalty (veh)			

**Intersection: 12: Shearer & Centre**

Movement	EB	EB	WB	WB	NB	SB
Directions Served	LT	R	LT	R	LTR	LTR
Maximum Queue (m)	20.1	3.7	19.9	13.2	21.5	42.1
Average Queue (m)	4.6	0.4	4.7	1.1	7.2	17.4
95th Queue (m)	14.3	2.9	13.9	6.5	17.1	33.0
Link Distance (m)	231.8		136.6		152.8	73.8
Upstream Blk Time (%)						
Queuing Penalty (veh)						
Storage Bay Dist (m)		15.0		15.0		
Storage Blk Time (%)	3		1	0	13	32
Queuing Penalty (veh)	0		0	0	0	4

**Intersection: 13: rue Sucrierie & Centre**

Movement	EB	WB	WB	NB	SB
Directions Served	LTR	LT	R	LTR	LTR
Maximum Queue (m)	55.2	45.2	22.4	16.3	5.8
Average Queue (m)	23.2	16.4	12.2	6.2	0.5
95th Queue (m)	43.6	36.2	24.4	14.4	3.5
Link Distance (m)	136.6	99.5		156.3	73.1
Upstream Blk Time (%)					
Queuing Penalty (veh)					
Storage Bay Dist (m)			15.0		
Storage Blk Time (%)	40	11	5	13	1
Queuing Penalty (veh)	2	10	6	1	0

**Intersection: 14: rue Centre/Centre**

Movement	EB	SB
Directions Served	LT	LR
Maximum Queue (m)	15.0	14.1
Average Queue (m)	3.3	5.8
95th Queue (m)	11.6	13.5
Link Distance (m)	99.5	72.5
Upstream Blk Time (%)		
Queuing Penalty (veh)		
Storage Bay Dist (m)		
Storage Blk Time (%)		
Queuing Penalty (veh)		

**Intersection: 15: Rue Wellington & rue Centre/accès**

Movement	EB	WB	NB	NB	SB	SB
Directions Served	LTR	LTR	LT	TR	LT	TR
Maximum Queue (m)	33.6	15.5	19.7	22.0	86.8	106.8
Average Queue (m)	14.5	4.7	9.4	7.5	20.5	39.4
95th Queue (m)	28.1	13.7	18.6	18.6	55.2	83.3
Link Distance (m)	167.7	202.8	78.0	78.0	177.9	177.9
Upstream Blk Time (%)						
Queuing Penalty (veh)						
Storage Bay Dist (m)						
Storage Blk Time (%)						
Queuing Penalty (veh)						

**Intersection: 16: Shearer & Richardson**

Movement	WB	NB
Directions Served	LTR	T
Maximum Queue (m)	18.3	6.6
Average Queue (m)	10.0	0.3
95th Queue (m)	15.0	2.8
Link Distance (m)	145.7	73.8
Upstream Blk Time (%)		
Queuing Penalty (veh)		
Storage Bay Dist (m)		
Storage Blk Time (%)		
Queuing Penalty (veh)		

**Intersection: 17: rue Sucrierie & Richardson**

Movement	WB	NB	SB
Directions Served	LTR	LT	TR
Maximum Queue (m)	11.9	19.2	7.3
Average Queue (m)	9.1	10.5	0.8
95th Queue (m)	12.2	15.6	4.9
Link Distance (m)	96.0	73.1	83.1
Upstream Blk Time (%)			
Queuing Penalty (veh)			
Storage Bay Dist (m)			
Storage Blk Time (%)			
Queuing Penalty (veh)			

**Intersection: 18: Richardson & Montmorency**

Movement	WB	NB	SB
Directions Served	LTR	LT	TR
Maximum Queue (m)	16.6	16.0	16.2
Average Queue (m)	7.3	9.5	8.6
95th Queue (m)	14.9	12.6	14.9
Link Distance (m)	197.6	72.5	35.8
Upstream Blk Time (%)			
Queuing Penalty (veh)			
Storage Bay Dist (m)			
Storage Blk Time (%)			
Queuing Penalty (veh)			

Intersection: 19: rue de la Prairie & Rue Centre

Movement	EB	WB	NB	SB
Directions Served	LTR	LTR	LTR	LTR
Maximum Queue (m)	31.1	16.8	14.4	13.0
Average Queue (m)	15.3	4.1	4.0	3.9
95th Queue (m)	28.0	12.7	12.3	12.0
Link Distance (m)	127.7	127.0	236.4	120.7
Upstream Blk Time (%)				
Queuing Penalty (veh)				
Storage Bay Dist (m)				
Storage Blk Time (%)				
Queuing Penalty (veh)				

Intersection: 20: Rue Bridge & Rue Wellington

Movement	EB	EB	EB	WB	WB	WB	NB	NB	NB	SB	SB
Directions Served	T	T	R	L	LT	TR	LT	TR	R	T	TR
Maximum Queue (m)	82.5	81.1	14.4	29.2	61.2	63.9	200.0	220.2	80.0	21.2	26.3
Average Queue (m)	43.7	42.6	5.5	8.7	37.0	37.0	99.5	111.6	69.4	3.9	9.9
95th Queue (m)	67.7	65.2	13.5	20.7	56.2	58.1	175.8	207.5	92.6	14.5	22.3
Link Distance (m)	177.9	177.9		167.6	167.6		409.0	409.0		148.6	148.6
Upstream Blk Time (%)											
Queuing Penalty (veh)											
Storage Bay Dist (m)			0.1			70.0			60.0		
Storage Blk Time (%)		60	2		0	0		20	10		
Queuing Penalty (veh)		17	3		1	0		93	70		

Intersection: 21: Rue Ropery & Rue Centre

Movement	EB	WB	SB
Directions Served	LT	LT	LTR
Maximum Queue (m)	35.5	30.9	6.8
Average Queue (m)	15.0	14.8	0.9
95th Queue (m)	29.5	27.2	4.7
Link Distance (m)	218.4	127.7	118.3
Upstream Blk Time (%)			
Queuing Penalty (veh)			
Storage Bay Dist (m)			
Storage Blk Time (%)	12	0	
Queuing Penalty (veh)	0	0	



**Intersection: 23: Rue Island & Rue Centre**

Movement	EB	WB	NB
Directions Served	LT	TR	LTR
Maximum Queue (m)	37.8	24.3	22.6
Average Queue (m)	20.4	6.5	8.2
95th Queue (m)	34.6	17.0	19.4
Link Distance (m)	127.0	231.8	155.4
Upstream Blk Time (%)			
Queuing Penalty (veh)			
Storage Bay Dist (m)			
Storage Blk Time (%)			15
Queuing Penalty (veh)			1

**Intersection: 38:**

Movement	EB	WB
Directions Served	T	LT
Maximum Queue (m)	3.6	5.4
Average Queue (m)	0.1	0.2
95th Queue (m)	1.9	2.3
Link Distance (m)	16.5	26.6
Upstream Blk Time (%)		
Queuing Penalty (veh)		
Storage Bay Dist (m)		
Storage Blk Time (%)		
Queuing Penalty (veh)		

**Intersection: 40:**

Movement
Directions Served
Maximum Queue (m)
Average Queue (m)
95th Queue (m)
Link Distance (m)
Upstream Blk Time (%)
Queuing Penalty (veh)
Storage Bay Dist (m)
Storage Blk Time (%)
Queuing Penalty (veh)

Intersection: 45: St-Patrick/Rue Saint-Patrick

Movement	EB	B39	WB	NB	NB
Directions Served	LT	T	TR	LT	R
Maximum Queue (m)	164.6	72.1	57.4	28.1	18.3
Average Queue (m)	75.2	13.3	22.9	7.9	11.6
95th Queue (m)	169.7	87.2	40.4	19.2	19.5
Link Distance (m)	158.1	365.4	159.4	161.3	
Upstream Blk Time (%)	12				
Queuing Penalty (veh)	63				
Storage Bay Dist (m)					10.0
Storage Blk Time (%)				4	11
Queuing Penalty (veh)				2	5

Network Summary

Network wide Queuing Penalty: 745

1: rue St-Patrick & rue Charlevoix Performance by movement

Movement	EBL	EBT	EBR	WBL	WBT	WBR	NBL	NBT	NBR	SBL	SBT	SBR
Denied Delay (hr)	0.0	0.1	0.0	0.0	0.0	0.0	0.1	0.2	0.0	0.0	0.0	0.0
Denied Del/Veh (s)	0.7	0.8	1.8	0.0	0.0	0.3	2.8	2.9	0.0	0.2	0.2	0.3
Total Delay (hr)	5.1	13.2	0.5	0.0	0.7	0.3	2.5	5.0	0.5	0.3	0.8	0.7
Total Del/Veh (s)	86.9	89.2	80.7	12.8	10.2	13.1	72.1	77.4	74.7	35.3	31.1	30.1
Vehicles Entered	203	509	23	3	251	86	121	227	21	26	93	76
Vehicles Exited	203	508	23	4	248	87	120	229	21	27	93	75
Hourly Exit Rate	203	508	23	4	248	87	120	229	21	27	93	75
Input Volume	207	498	22	6	253	90	116	245	23	25	98	77
% of Volume	98	102	105	67	98	97	103	93	91	108	95	97

1: rue St-Patrick & rue Charlevoix Performance by movement

Movement	All
Denied Delay (hr)	0.5
Denied Del/Veh (s)	1.0
Total Delay (hr)	29.6
Total Del/Veh (s)	63.0
Vehicles Entered	1639
Vehicles Exited	1638
Hourly Exit Rate	1638
Input Volume	1660
% of Volume	99

2: des Seigneurs & St-Patrick Performance by movement

Movement	EBL	EBT	EBR	WBT	WBR	NBR	SBL	SBT	SBR	All
Denied Delay (hr)	0.0	0.5	0.0	0.0	0.1	0.0	0.0	0.0	0.0	0.6
Denied Del/Veh (s)	0.1	3.8	0.0	0.3	0.5	0.1	0.3	0.3	3.4	1.5
Total Delay (hr)	2.8	7.9	0.0	1.7	3.2	0.0	1.2	0.0	0.2	17.1
Total Del/Veh (s)	69.8	62.2	44.1	23.1	29.7	16.6	32.0	33.7	17.6	43.0
Vehicles Entered	145	454	1	257	387	3	131	3	36	1417
Vehicles Exited	142	449	1	256	386	3	130	3	35	1405
Hourly Exit Rate	142	449	1	256	386	3	130	3	35	1405
Input Volume	150	451	1	260	399	1	131	2	36	1432
% of Volume	95	100	100	98	97	300	99	150	97	98

3: Shearer/accès & St-Patrick Performance by movement

Movement	EBL	EBT	EBR	WBL	WBT	NBL	NBT	NBR	SBR	All
Denied Delay (hr)	0.0	0.0	0.0	0.0	0.0	0.0	0.0	0.0	0.0	0.0
Denied Del/Veh (s)		0.0	0.0	0.0	0.1	0.0	0.0	0.6	0.1	0.1
Total Delay (hr)	0.0	0.2	0.0	0.0	0.6	0.4	0.0	0.1	0.0	1.4
Total Del/Veh (s)		1.3	0.8	9.3	4.0	27.6	0.4	8.8	14.4	3.9
Vehicles Entered	0	553	28	10	579	53	2	44	1	1270
Vehicles Exited	0	552	28	10	582	53	2	44	1	1272
Hourly Exit Rate	0	552	28	10	582	53	2	44	1	1272
Input Volume	1	549	33	10	599	53	4	42	1	1292
% of Volume	0	101	85	100	97	100	50	105	100	98

4: St-Patrick Performance by movement

Movement	EBT	EBR	WBL	WBT	NBL	NBR	All
Denied Delay (hr)	0.0	0.0	0.0	0.0	0.0	0.0	0.0
Denied Del/Veh (s)	0.1	0.0	0.1	0.1	0.0	0.0	0.1
Total Delay (hr)	0.2	0.0	0.1	0.4	0.2	0.2	1.2
Total Del/Veh (s)	1.3	0.8	6.2	2.5	18.3	10.6	3.1
Vehicles Entered	588	41	40	546	47	81	1343
Vehicles Exited	588	41	40	548	47	81	1345
Hourly Exit Rate	588	41	40	548	47	81	1345
Input Volume	588	42	44	571	42	83	1370
% of Volume	100	98	91	96	112	98	98

5: Montmorency & St-Patrick Performance by movement

Movement	EBT	EBR	WBL	WBT	WBR	NBL	NBT	NBR	SBL	SBR	All
Denied Delay (hr)	0.0	0.0	2.2	4.5	0.0	0.0	0.0	0.0	0.0	0.0	6.8
Denied Del/Veh (s)	0.4	0.3	40.5	29.4	29.7	0.9	0.0	0.0	0.1	0.1	16.0
Total Delay (hr)	0.5	0.7	4.0	10.2	0.1	0.4	0.0	0.5	0.1	0.1	16.6
Total Del/Veh (s)	5.9	7.9	73.5	66.7	57.7	33.5	1.1	41.2	28.9	38.6	39.1
Vehicles Entered	334	330	189	540	4	48	4	48	7	5	1509
Vehicles Exited	334	330	190	536	3	48	4	48	7	5	1505
Hourly Exit Rate	334	330	190	536	3	48	4	48	7	5	1505
Input Volume	340	326	198	565	3	45	5	43	8	4	1537
% of Volume	98	101	96	95	100	107	80	112	88	125	98

6: Rue Bridge & Rue Saint-Patrick Performance by movement

Movement	EBT	EBR	WBL	WBT	NBL	NBT	NBR	All
Denied Delay (hr)	0.0	0.0	0.0	0.3	0.0	0.0	0.0	0.3
Denied Del/Veh (s)	0.0	0.0	0.0	3.4	0.2	0.0	0.0	1.0
Total Delay (hr)	1.8	0.1	0.1	5.6	3.3	0.0	0.0	10.9
Total Del/Veh (s)	22.4	3.3	52.0	64.3	26.8	3.6	3.3	34.3
Vehicles Entered	293	56	4	310	443	22	6	1134
Vehicles Exited	293	56	5	306	435	22	6	1123
Hourly Exit Rate	293	56	5	306	435	22	6	1123
Input Volume	292	57	5	320	435	22	6	1137
% of Volume	100	98	100	96	100	100	100	99

7: Rue Wellington & Rue Saint-Patrick Performance by movement

Movement	EBL	EBT	NBL	NBT	SBT	SBR	All
Denied Delay (hr)	0.0	0.0	0.0	0.0	0.0	0.2	0.3
Denied Del/Veh (s)	0.1	0.0	0.0	0.0	0.5	3.2	0.5
Total Delay (hr)	5.4	0.0	0.0	2.9	1.1	1.2	10.7
Total Del/Veh (s)	80.6	1.9	33.5	7.9	13.3	15.9	17.7
Vehicles Entered	236	15	2	1311	304	276	2144
Vehicles Exited	235	15	2	1311	303	280	2146
Hourly Exit Rate	235	15	2	1311	303	280	2146
Input Volume	240	15	2	1309	297	288	2151
% of Volume	98	100	100	100	102	97	100

8: rue Charlevoix & Rue Centre Performance by movement

Movement	EBL	EBT	EBR	WBL	WBT	WBR	NBL	NBT	NBR	SBL	SBT	SBR
Denied Delay (hr)	0.0	0.0	0.0	0.0	0.0	0.0	0.0	0.0	0.0	0.0	0.0	0.0
Denied Del/Veh (s)	0.4	0.4	0.3	0.0	0.0	0.0	0.2	0.2	0.2	0.0	0.0	0.0
Total Delay (hr)	0.4	1.1	0.2	0.1	0.2	0.2	0.0	0.9	0.0	0.1	0.4	0.0
Total Del/Veh (s)	17.1	16.3	17.3	26.9	13.7	18.3	17.0	13.8	13.9	17.6	13.8	13.2
Vehicles Entered	82	238	34	19	57	33	10	232	10	12	105	3
Vehicles Exited	84	238	35	19	56	33	10	232	10	12	105	3
Hourly Exit Rate	84	238	35	19	56	33	10	232	10	12	105	3
Input Volume	87	231	35	20	53	38	8	237	9	15	109	3
% of Volume	97	103	100	95	106	87	125	98	111	80	96	100

8: rue Charlevoix & Rue Centre Performance by movement

Movement	All
Denied Delay (hr)	0.1
Denied Del/Veh (s)	0.2
Total Delay (hr)	3.6
Total Del/Veh (s)	15.5
Vehicles Entered	835
Vehicles Exited	837
Hourly Exit Rate	837
Input Volume	845
% of Volume	99

## 9: rue Sucrierie Performance by movement

Movement	EBL	EBR	NBL	NBT	SBT	SBR	All
Denied Delay (hr)	0.0	0.0	0.0	0.0	0.0	0.0	0.0
Denied Del/Veh (s)	0.0	0.0	0.0	0.0	0.0	0.0	0.0
Total Delay (hr)	0.0	0.0	0.1	0.0	0.0	0.0	0.2
Total Del/Veh (s)	3.9	2.8	3.2	1.6	0.9	0.4	2.0
Vehicles Entered	42	4	64	85	1	80	276
Vehicles Exited	43	4	64	85	1	80	277
Hourly Exit Rate	43	4	64	85	1	80	277
Input Volume	42	4	68	83	1	85	283
% of Volume	102	100	94	102	100	94	98

## 10: Montmorency Performance by movement

Movement	EBL	NBT	SBT	SBR	All
Denied Delay (hr)	0.0	0.0	0.0	0.0	0.0
Denied Del/Veh (s)	0.1	0.0	0.0	0.0	0.0
Total Delay (hr)	0.1	0.0	0.1	0.0	0.1
Total Del/Veh (s)	7.7	0.9	0.5	0.4	0.8
Vehicles Entered	27	66	389	141	623
Vehicles Exited	27	66	389	140	622
Hourly Exit Rate	27	66	389	140	622
Input Volume	28	59	386	150	623
% of Volume	96	112	101	93	100

## 11: Montmorency Performance by movement

Movement	EBL	EBR	NBL	NBT	SBT	SBR	All
Denied Delay (hr)	0.0	0.0	0.0	0.0	0.0	0.0	0.0
Denied Del/Veh (s)	0.2	0.2	0.1	0.1	0.0	0.0	0.0
Total Delay (hr)	0.1	0.0	0.1	0.0	0.0	0.1	0.3
Total Del/Veh (s)	5.6	3.2	5.0	2.0	1.6	0.8	2.2
Vehicles Entered	42	16	107	24	73	298	560
Vehicles Exited	42	16	107	24	73	298	560
Hourly Exit Rate	42	16	107	24	73	298	560
Input Volume	38	17	105	21	71	298	550
% of Volume	111	94	102	114	103	100	102

12: Shearer & Centre Performance by movement

Movement	EBL	EBT	EBR	WBL	WBT	WBR	NBL	NBT	NBR	SBL	SBT	SBR
Denied Delay (hr)	0.0	0.0	0.0	0.0	0.0	0.0	0.0	0.0	0.0	0.0	0.0	0.0
Denied Del/Veh (s)	0.0	0.0	0.0	0.0	0.0	0.0	0.2	0.1	0.1	0.1	0.0	0.1
Total Delay (hr)	0.0	0.2	0.0	0.0	0.1	0.0	0.0	0.1	0.0	0.2	0.3	0.1
Total Del/Veh (s)	6.7	4.9	5.2	8.3	4.5	4.2	20.0	11.0	9.7	14.9	13.8	16.1
Vehicles Entered	11	143	14	9	98	17	6	38	7	43	87	22
Vehicles Exited	12	143	14	9	98	16	7	38	7	43	86	22
Hourly Exit Rate	12	143	14	9	98	16	7	38	7	43	86	22
Input Volume	13	133	13	11	105	15	9	35	7	45	80	25
% of Volume	92	108	108	82	93	107	78	109	100	96	108	88

12: Shearer & Centre Performance by movement

Movement	All
Denied Delay (hr)	0.0
Denied Del/Veh (s)	0.0
Total Delay (hr)	1.2
Total Del/Veh (s)	8.6
Vehicles Entered	495
Vehicles Exited	495
Hourly Exit Rate	495
Input Volume	491
% of Volume	101

13: rue Sucrierie & Centre Performance by movement

Movement	EBL	EBT	EBR	WBL	WBT	WBR	NBL	NBT	NBR	SBL	SBT	SBR
Denied Delay (hr)	0.0	0.0	0.0	0.0	0.0	0.0	0.0	0.0	0.0	0.0	0.0	0.0
Denied Del/Veh (s)	0.0	0.0	0.0	0.0	0.1	0.0	0.1	0.1	0.1	0.0	0.0	0.0
Total Delay (hr)	0.3	0.6	0.1	0.1	0.3	0.3	0.0	0.0	0.1	0.0	0.0	0.0
Total Del/Veh (s)	20.5	17.7	19.8	12.7	8.9	12.1	11.2	9.5	10.7	6.8	0.9	15.5
Vehicles Entered	55	122	15	16	136	95	15	14	26	2	6	2
Vehicles Exited	55	121	15	17	135	94	15	14	27	2	6	2
Hourly Exit Rate	55	121	15	17	135	94	15	14	27	2	6	2
Input Volume	53	120	12	18	138	96	17	15	22	2	5	2
% of Volume	104	101	125	94	98	98	88	93	123	100	120	100

13: rue Sucrierie & Centre Performance by movement

Movement	All
Denied Delay (hr)	0.0
Denied Del/Veh (s)	0.0
Total Delay (hr)	1.9
Total Del/Veh (s)	13.5
Vehicles Entered	504
Vehicles Exited	503
Hourly Exit Rate	503
Input Volume	500
% of Volume	101

14: rue Centre/Centre Performance by movement

Movement	EBL	EBT	WBT	WBR	SBL	SBR	All
Denied Delay (hr)	0.0	0.0	0.0	0.0	0.0	0.0	0.0
Denied Del/Veh (s)	0.0	0.0	0.1	0.3	0.0	0.0	0.1
Total Delay (hr)	0.0	0.1	0.1	0.0	0.0	0.0	0.2
Total Del/Veh (s)	3.5	1.6	0.4	0.2	7.4	4.1	1.0
Vehicles Entered	40	116	488	80	21	6	751
Vehicles Exited	39	116	490	80	21	6	752
Hourly Exit Rate	39	116	490	80	21	6	752
Input Volume	35	113	493	78	22	5	746
% of Volume	111	103	99	103	95	120	101

15: Rue Wellington & rue Centre/Accès Performance by movement

Movement	EBL	EBT	EBR	WBL	WBR	NBT	SBT	SBR	All
Denied Delay (hr)	0.0	0.0	0.0	0.0	0.0	0.0	0.0	0.0	0.0
Denied Del/Veh (s)	0.0	0.0	0.0		0.1	0.0	0.0	0.6	0.2
Total Delay (hr)	0.6	0.0	0.0	0.0	0.2	0.3	0.6	0.6	2.3
Total Del/Veh (s)	31.8	0.3	22.8		36.5	3.6	6.5	7.7	7.9
Vehicles Entered	70	53	2	0	17	292	351	267	1052
Vehicles Exited	69	53	2	0	17	292	351	268	1052
Hourly Exit Rate	69	53	2	0	17	292	351	268	1052
Input Volume	71	51	2	1	16	290	340	268	1039
% of Volume	97	104	100	0	106	101	103	100	101

16: Shearer & Richardson Performance by movement

Movement	WBL	WBR	NBT	SBT	All
Denied Delay (hr)	0.0	0.0	0.0	0.0	0.0
Denied Del/Veh (s)	0.0	0.0	0.0	0.0	0.0
Total Delay (hr)	0.2	0.0	0.0	0.0	0.2
Total Del/Veh (s)	6.6	5.1	0.9	0.3	3.6
Vehicles Entered	96	25	72	37	230
Vehicles Exited	97	25	73	37	232
Hourly Exit Rate	97	25	73	37	232
Input Volume	90	24	70	43	227
% of Volume	108	104	104	86	102



**17: rue Sucrierie & Richardson Performance by movement**

Movement	WBL	WBT	WBR	NBL	NBT	SBT	SBR	All
Denied Delay (hr)	0.0	0.0	0.0	0.0	0.0	0.0	0.0	0.0
Denied Del/Veh (s)	0.0	0.0	0.0	0.0	0.0	0.0	0.0	0.0
Total Delay (hr)	0.0	0.2	0.0	0.0	0.2	0.0	0.0	0.4
Total Del/Veh (s)	4.9	5.5	3.9	5.2	4.6	2.6	3.0	4.9
Vehicles Entered	7	105	6	19	144	4	1	286
Vehicles Exited	8	105	6	19	144	4	1	287
Hourly Exit Rate	8	105	6	19	144	4	1	287
Input Volume	7	97	5	19	145	3	1	277
% of Volume	114	108	120	100	99	133	100	104

**18: Richardson & Montmorency Performance by movement**

Movement	WBL	WBT	WBR	NBL	NBT	SBT	SBR	All
Denied Delay (hr)	0.0	0.0	0.0	0.0	0.0	0.0	0.0	0.0
Denied Del/Veh (s)	0.1	0.1	0.2	0.0	0.0	0.0	0.0	0.0
Total Delay (hr)	0.0	0.0	0.0	0.0	0.1	0.0	0.0	0.3
Total Del/Veh (s)	5.1	5.0	3.1	4.2	4.8	2.9	2.9	4.0
Vehicles Entered	2	34	8	29	97	34	55	259
Vehicles Exited	2	34	8	29	97	34	55	259
Hourly Exit Rate	2	34	8	29	97	34	55	259
Input Volume	2	30	9	28	93	37	51	250
% of Volume	100	113	89	104	104	92	108	104

**19: rue de la Prairie & Rue Centre Performance by movement**

Movement	EBL	EBT	WBT	NBL	SBR	All
Denied Delay (hr)	0.0	0.0	0.0	0.0	0.0	0.0
Denied Del/Veh (s)	0.0	0.0	0.0	0.1	0.1	0.0
Total Delay (hr)	0.2	0.5	0.1	0.1	0.1	0.9
Total Del/Veh (s)	8.1	8.9	5.2	10.6	9.6	8.3
Vehicles Entered	91	182	53	24	28	378
Vehicles Exited	91	182	53	24	28	378
Hourly Exit Rate	91	182	53	24	28	378
Input Volume	95	172	54	24	25	370
% of Volume	96	106	98	100	112	102

20: Rue Bridge & Rue Wellington Performance by movement

Movement	EBT	EBR	WBL	WBT	WBR	NBL	NBT	NBR	SBT	SBR	All
Denied Delay (hr)	0.0	0.0	0.0	0.0	0.0	0.0	0.1	0.1	0.0	0.0	0.2
Denied Del/Veh (s)	0.0	0.3	0.0	0.3	0.7	0.5	0.5	0.5	0.0	0.1	0.4
Total Delay (hr)	4.5	0.3	0.6	5.0	0.6	1.7	6.2	9.3	0.6	0.1	28.8
Total Del/Veh (s)	41.3	35.8	62.3	67.9	65.4	51.9	50.2	34.6	35.8	46.1	44.1
Vehicles Entered	385	29	33	259	32	115	439	951	58	8	2309
Vehicles Exited	387	29	33	260	32	113	434	948	58	9	2303
Hourly Exit Rate	387	29	33	260	32	113	434	948	58	9	2303
Input Volume	384	28	35	255	31	110	426	949	58	11	2287
% of Volume	101	104	94	102	103	103	102	100	100	82	101

21: Rue Ropery & Rue Centre Performance by movement

Movement	EBT	WBT	SBR	All
Denied Delay (hr)	0.0	0.0	0.0	0.0
Denied Del/Veh (s)	0.0	0.0	0.1	0.0
Total Delay (hr)	0.6	0.3	0.0	0.9
Total Del/Veh (s)	7.8	10.6	11.2	8.6
Vehicles Entered	269	108	7	384
Vehicles Exited	269	107	7	383
Hourly Exit Rate	269	107	7	383
Input Volume	262	106	9	377
% of Volume	103	101	78	102

23: Rue Island & Rue Centre Performance by movement

Movement	EBL	EBT	WBT	WBR	NBL	NBT	NBR	All
Denied Delay (hr)	0.0	0.0	0.0	0.0	0.0	0.0	0.0	0.0
Denied Del/Veh (s)	0.0	0.0	0.0	0.0	0.2	0.1	0.1	0.0
Total Delay (hr)	0.1	0.8	0.1	0.0	0.0	0.1	0.0	1.2
Total Del/Veh (s)	16.0	16.9	4.1	10.9	12.1	11.8	15.2	12.2
Vehicles Entered	12	165	105	9	8	42	11	352
Vehicles Exited	12	165	106	9	8	42	11	353
Hourly Exit Rate	12	165	106	9	8	42	11	353
Input Volume	13	156	116	11	7	42	11	356
% of Volume	92	106	91	82	114	100	100	99

**38: Performance by movement**

Movement	EBT	WBL	WBT	NER	All
Denied Delay (hr)	0.0	0.0	0.0	0.0	0.0
Denied Del/Veh (s)	0.1	0.0	0.0	0.1	0.0
Total Delay (hr)	0.0	0.0	0.0	0.0	0.0
Total Del/Veh (s)	0.6	0.9	0.2	0.0	0.4
Vehicles Entered	28	56	88	18	190
Vehicles Exited	28	56	88	18	190
Hourly Exit Rate	28	56	88	18	190
Input Volume	28	60	93	17	198
% of Volume	100	93	95	106	96

**40: Performance by movement**

Movement	NBT	All
Denied Delay (hr)	0.0	0.0
Denied Del/Veh (s)	0.0	0.0
Total Delay (hr)	0.0	0.0
Total Del/Veh (s)	0.8	0.8
Vehicles Entered	75	75
Vehicles Exited	75	75
Hourly Exit Rate	75	75
Input Volume	78	78
% of Volume	96	96

**45: St-Patrick/Rue Saint-Patrick Performance by movement**

Movement	EBT	WBT	NBL	NBR	All
Denied Delay (hr)	1.8	0.0	0.0	0.0	1.8
Denied Del/Veh (s)	10.8	0.0	0.1	1.2	6.6
Total Delay (hr)	6.7	0.8	0.1	0.2	7.6
Total Del/Veh (s)	40.2	9.5	5.8	8.8	27.8
Vehicles Entered	591	291	38	63	983
Vehicles Exited	583	292	38	63	976
Hourly Exit Rate	583	292	38	63	976
Input Volume	589	297	40	63	989
% of Volume	99	98	95	100	99

Total Network Performance

Denied Delay (hr)	10.7
Denied Del/Veh (s)	6.7
Total Delay (hr)	142.1
Total Del/Veh (s)	85.0
Vehicles Entered	5751
Vehicles Exited	5713
Hourly Exit Rate	5713
Input Volume	26948
% of Volume	21

**Intersection: 1: rue St-Patrick & rue Charlevoix**

Movement	EB	EB	WB	WB	NB	SB
Directions Served	LT	R	LT	R	LTR	LTR
Maximum Queue (m)	360.6	37.5	47.0	37.2	163.2	74.1
Average Queue (m)	205.9	9.2	20.9	12.3	93.8	33.4
95th Queue (m)	414.2	34.4	43.1	30.2	155.0	59.2
Link Distance (m)	519.1		365.4		213.7	892.0
Upstream Blk Time (%)						
Queuing Penalty (veh)						
Storage Bay Dist (m)		30.0		30.0		
Storage Blk Time (%)	54	0	3	0	74	52
Queuing Penalty (veh)	12	1	3	1	8	20

**Intersection: 2: des Seigneurs & St-Patrick**

Movement	EB	EB	WB	WB	NB	SB	SB
Directions Served	LT	TR	LT	R	LTR	LT	R
Maximum Queue (m)	164.3	37.5	66.8	71.6	7.2	71.5	18.0
Average Queue (m)	122.3	11.9	36.0	51.8	0.5	27.2	6.7
95th Queue (m)	201.1	39.3	60.9	77.6	3.8	53.7	17.3
Link Distance (m)	159.4		57.6	57.6	57.0	286.2	
Upstream Blk Time (%)	14		2	11			
Queuing Penalty (veh)	82		5	36			
Storage Bay Dist (m)		30.0					5.0
Storage Blk Time (%)	55	0				51	6
Queuing Penalty (veh)	123	0				18	8

**Intersection: 3: Shearer/accès & St-Patrick**

Movement	EB	EB	WB	NB	NB	SB
Directions Served	LT	R	LTR	LT	R	LTR
Maximum Queue (m)	24.6	3.2	80.5	32.3	22.2	3.4
Average Queue (m)	2.0	0.1	16.2	10.6	8.4	0.1
95th Queue (m)	12.8	1.7	54.4	24.3	20.1	1.8
Link Distance (m)	57.6	57.6	141.4	164.9		88.0
Upstream Blk Time (%)						
Queuing Penalty (veh)						
Storage Bay Dist (m)					15.0	
Storage Blk Time (%)				11	1	
Queuing Penalty (veh)				5	1	

**Intersection: 4: St-Patrick**

Movement	EB	WB	NB
Directions Served	TR	LT	LR
Maximum Queue (m)	4.3	49.6	37.6
Average Queue (m)	0.3	10.3	14.8
95th Queue (m)	3.0	33.6	27.2
Link Distance (m)	141.4	93.8	72.7
Upstream Blk Time (%)			
Queuing Penalty (veh)			
Storage Bay Dist (m)			
Storage Blk Time (%)			
Queuing Penalty (veh)			

**Intersection: 5: Montmorency & St-Patrick**

Movement	EB	EB	WB	NB	NB	SB
Directions Served	T	R	LTR	LT	R	LTR
Maximum Queue (m)	85.9	22.5	201.0	28.3	24.6	12.6
Average Queue (m)	34.1	18.0	162.6	12.5	11.4	2.8
95th Queue (m)	74.9	27.8	245.2	25.4	22.9	9.5
Link Distance (m)	93.8		197.5	26.2	26.2	55.1
Upstream Blk Time (%)	0		8	1	1	
Queuing Penalty (veh)	0		57	1	0	
Storage Bay Dist (m)		15.0				
Storage Blk Time (%)	7	13	57			10
Queuing Penalty (veh)	24	39	1			0

**Intersection: 6: Rue Bridge & Rue Saint-Patrick**

Movement	EB	EB	WB	WB	NB	NB
Directions Served	T	R	L	T	L	TR
Maximum Queue (m)	70.7	15.7	50.1	124.3	132.1	36.4
Average Queue (m)	37.3	3.0	2.1	66.0	48.0	2.3
95th Queue (m)	63.3	11.1	33.6	144.6	125.3	29.8
Link Distance (m)	197.5	197.5	225.8	225.8	148.6	148.6
Upstream Blk Time (%)			0	3	1	0
Queuing Penalty (veh)			0	4	2	0
Storage Bay Dist (m)						
Storage Blk Time (%)						
Queuing Penalty (veh)						

**Intersection: 7: Rue Wellington & Rue Saint-Patrick**

Movement	EB	NB	NB	SB	SB	SB
Directions Served	L	LT	T	T	T	R
Maximum Queue (m)	91.7	92.5	96.2	81.7	100.7	9.3
Average Queue (m)	52.6	41.0	45.5	17.1	47.5	8.9
95th Queue (m)	81.4	75.0	77.6	57.9	85.8	9.5
Link Distance (m)	225.8	167.6	167.6	261.8	261.8	
Upstream Blk Time (%)						
Queuing Penalty (veh)						
Storage Bay Dist (m)						0.1
Storage Blk Time (%)					0	0
Queuing Penalty (veh)					0	0

**Intersection: 8: rue Charlevoix & Rue Centre**

Movement	EB	WB	NB	SB
Directions Served	LTR	LTR	LTR	LTR
Maximum Queue (m)	75.7	35.6	47.6	40.6
Average Queue (m)	40.0	16.1	25.2	16.2
95th Queue (m)	66.6	30.0	42.0	33.0
Link Distance (m)	180.1	218.4	404.2	213.7
Upstream Blk Time (%)				
Queuing Penalty (veh)				
Storage Bay Dist (m)				
Storage Blk Time (%)	46	27		
Queuing Penalty (veh)	8	5		

**Intersection: 9: rue Sucrierie**

Movement	EB	NB	SB
Directions Served	LR	LT	TR
Maximum Queue (m)	12.1	12.9	4.0
Average Queue (m)	7.5	2.4	0.1
95th Queue (m)	13.3	9.6	1.4
Link Distance (m)	26.6	83.1	72.7
Upstream Blk Time (%)			
Queuing Penalty (veh)			
Storage Bay Dist (m)			
Storage Blk Time (%)			
Queuing Penalty (veh)			

**Intersection: 10: Montmorency**

Movement	EB	NB
Directions Served	LR	LT
Maximum Queue (m)	14.0	1.8
Average Queue (m)	4.5	0.1
95th Queue (m)	10.7	1.3
Link Distance (m)	35.6	79.8
Upstream Blk Time (%)		
Queuing Penalty (veh)		
Storage Bay Dist (m)		
Storage Blk Time (%)		
Queuing Penalty (veh)		

**Intersection: 11: Montmorency**

Movement	EB	NB	SB
Directions Served	LR	LT	TR
Maximum Queue (m)	21.9	24.0	10.1
Average Queue (m)	8.9	9.9	1.3
95th Queue (m)	17.3	20.4	6.1
Link Distance (m)	27.0	35.8	79.8
Upstream Blk Time (%)	0	0	
Queuing Penalty (veh)	0	0	
Storage Bay Dist (m)			
Storage Blk Time (%)			
Queuing Penalty (veh)			

**Intersection: 12: Shearer & Centre**

Movement	EB	EB	WB	WB	NB	SB
Directions Served	LT	R	LT	R	LTR	LTR
Maximum Queue (m)	20.1	3.7	19.9	13.2	21.5	42.1
Average Queue (m)	4.6	0.4	4.7	1.1	7.2	17.4
95th Queue (m)	14.3	2.9	13.9	6.5	17.1	33.0
Link Distance (m)	231.8		136.6		152.8	73.8
Upstream Blk Time (%)						
Queuing Penalty (veh)						
Storage Bay Dist (m)		15.0		15.0		
Storage Blk Time (%)	3		1	0	13	32
Queuing Penalty (veh)	0		0	0	0	4



**Intersection: 13: rue Sucrierie & Centre**

Movement	EB	WB	WB	NB	SB
Directions Served	LTR	LT	R	LTR	LTR
Maximum Queue (m)	55.2	45.2	22.4	16.3	5.8
Average Queue (m)	23.2	16.4	12.2	6.2	0.5
95th Queue (m)	43.6	36.2	24.4	14.4	3.5
Link Distance (m)	136.6	99.5		156.3	73.1
Upstream Blk Time (%)					
Queuing Penalty (veh)					
Storage Bay Dist (m)			15.0		
Storage Blk Time (%)	40	11	5	13	1
Queuing Penalty (veh)	2	10	6	1	0

**Intersection: 14: rue Centre/Centre**

Movement	EB	SB
Directions Served	LT	LR
Maximum Queue (m)	15.0	14.1
Average Queue (m)	3.3	5.8
95th Queue (m)	11.6	13.5
Link Distance (m)	99.5	72.5
Upstream Blk Time (%)		
Queuing Penalty (veh)		
Storage Bay Dist (m)		
Storage Blk Time (%)		
Queuing Penalty (veh)		

**Intersection: 15: Rue Wellington & rue Centre/accès**

Movement	EB	WB	NB	NB	SB	SB
Directions Served	LTR	LTR	LT	TR	LT	TR
Maximum Queue (m)	33.6	15.5	19.7	22.0	86.8	106.8
Average Queue (m)	14.5	4.7	9.4	7.5	20.5	39.4
95th Queue (m)	28.1	13.7	18.6	18.6	55.2	83.3
Link Distance (m)	167.7	202.8	78.0	78.0	177.9	177.9
Upstream Blk Time (%)						
Queuing Penalty (veh)						
Storage Bay Dist (m)						
Storage Blk Time (%)						
Queuing Penalty (veh)						

**Intersection: 16: Shearer & Richardson**

Movement	WB	NB
Directions Served	LTR	T
Maximum Queue (m)	18.3	6.6
Average Queue (m)	10.0	0.3
95th Queue (m)	15.0	2.8
Link Distance (m)	145.7	73.8
Upstream Blk Time (%)		
Queuing Penalty (veh)		
Storage Bay Dist (m)		
Storage Blk Time (%)		
Queuing Penalty (veh)		

**Intersection: 17: rue Sucrierie & Richardson**

Movement	WB	NB	SB
Directions Served	LTR	LT	TR
Maximum Queue (m)	11.9	19.2	7.3
Average Queue (m)	9.1	10.5	0.8
95th Queue (m)	12.2	15.6	4.9
Link Distance (m)	96.0	73.1	83.1
Upstream Blk Time (%)			
Queuing Penalty (veh)			
Storage Bay Dist (m)			
Storage Blk Time (%)			
Queuing Penalty (veh)			

**Intersection: 18: Richardson & Montmorency**

Movement	WB	NB	SB
Directions Served	LTR	LT	TR
Maximum Queue (m)	16.6	16.0	16.2
Average Queue (m)	7.3	9.5	8.6
95th Queue (m)	14.9	12.6	14.9
Link Distance (m)	197.6	72.5	35.8
Upstream Blk Time (%)			
Queuing Penalty (veh)			
Storage Bay Dist (m)			
Storage Blk Time (%)			
Queuing Penalty (veh)			

**Intersection: 19: rue de la Prairie & Rue Centre**

Movement	EB	WB	NB	SB
Directions Served	LTR	LTR	LTR	LTR
Maximum Queue (m)	31.1	16.8	14.4	13.0
Average Queue (m)	15.3	4.1	4.0	3.9
95th Queue (m)	28.0	12.7	12.3	12.0
Link Distance (m)	127.7	127.0	236.4	120.7
Upstream Blk Time (%)				
Queuing Penalty (veh)				
Storage Bay Dist (m)				
Storage Blk Time (%)				
Queuing Penalty (veh)				

**Intersection: 20: Rue Bridge & Rue Wellington**

Movement	EB	EB	EB	WB	WB	WB	NB	NB	NB	SB	SB
Directions Served	T	T	R	L	LT	TR	LT	TR	R	T	TR
Maximum Queue (m)	82.5	81.1	14.4	29.2	61.2	63.9	200.0	220.2	80.0	21.2	26.3
Average Queue (m)	43.7	42.6	5.5	8.7	37.0	37.0	99.5	111.6	69.4	3.9	9.9
95th Queue (m)	67.7	65.2	13.5	20.7	56.2	58.1	175.8	207.5	92.6	14.5	22.3
Link Distance (m)	177.9	177.9		167.6	167.6		409.0	409.0		148.6	148.6
Upstream Blk Time (%)											
Queuing Penalty (veh)											
Storage Bay Dist (m)			0.1			70.0			60.0		
Storage Blk Time (%)		60	2		0	0		20	10		
Queuing Penalty (veh)		17	3		1	0		93	70		

**Intersection: 21: Rue Ropery & Rue Centre**

Movement	EB	WB	SB
Directions Served	LT	LT	LTR
Maximum Queue (m)	35.5	30.9	6.8
Average Queue (m)	15.0	14.8	0.9
95th Queue (m)	29.5	27.2	4.7
Link Distance (m)	218.4	127.7	118.3
Upstream Blk Time (%)			
Queuing Penalty (veh)			
Storage Bay Dist (m)			
Storage Blk Time (%)	12	0	
Queuing Penalty (veh)	0	0	

**Intersection: 23: Rue Island & Rue Centre**

Movement	EB	WB	NB
Directions Served	LT	TR	LTR
Maximum Queue (m)	37.8	24.3	22.6
Average Queue (m)	20.4	6.5	8.2
95th Queue (m)	34.6	17.0	19.4
Link Distance (m)	127.0	231.8	155.4
Upstream Blk Time (%)			
Queuing Penalty (veh)			
Storage Bay Dist (m)			
Storage Blk Time (%)			15
Queuing Penalty (veh)			1

**Intersection: 38:**

Movement	EB	WB
Directions Served	T	LT
Maximum Queue (m)	3.6	5.4
Average Queue (m)	0.1	0.2
95th Queue (m)	1.9	2.3
Link Distance (m)	16.5	26.6
Upstream Blk Time (%)		
Queuing Penalty (veh)		
Storage Bay Dist (m)		
Storage Blk Time (%)		
Queuing Penalty (veh)		

**Intersection: 40:**

Movement
Directions Served
Maximum Queue (m)
Average Queue (m)
95th Queue (m)
Link Distance (m)
Upstream Blk Time (%)
Queuing Penalty (veh)
Storage Bay Dist (m)
Storage Blk Time (%)
Queuing Penalty (veh)

Intersection: 45: St-Patrick/Rue Saint-Patrick

Movement	EB	B39	WB	NB	NB
Directions Served	LT	T	TR	LT	R
Maximum Queue (m)	164.6	72.1	57.4	28.1	18.3
Average Queue (m)	75.2	13.3	22.9	7.9	11.6
95th Queue (m)	169.7	87.2	40.4	19.2	19.5
Link Distance (m)	158.1	365.4	159.4	161.3	
Upstream Blk Time (%)	12				
Queuing Penalty (veh)	63				
Storage Bay Dist (m)					10.0
Storage Blk Time (%)				4	11
Queuing Penalty (veh)				2	5

Network Summary

Network wide Queuing Penalty: 745



Lane Group	EBT	EBR	WBL	WBT	WBR	NBL	NBT	NBR	SBL	SBT	SBR	Ø1
Lane Configurations	↑	↗		↔	↗		↑	↗		↔	↗	
Traffic Volume (vph)	297	25	48	541	3	7	0	15	8	0	4	
Future Volume (vph)	303	332	202	554	3	46	0	44	8	0	4	
Turn Type	NA	custom	custom	NA	custom	custom	NA	custom	custom	NA	custom	
Protected Phases	6			6			8			8		1
Permitted Phases		2	2		2	4		4	4		4	
Detector Phase												
Switch Phase												
Minimum Initial (s)	5.0	5.0	5.0	5.0	5.0	5.0	5.0	5.0	5.0	5.0	5.0	5.0
Minimum Split (s)	48.0	16.0	16.0	48.0	16.0	11.0	11.0	11.0	11.0	11.0	11.0	7.0
Total Split (s)	62.0	55.0	55.0	62.0	55.0	11.0	18.0	11.0	11.0	18.0	11.0	7.0
Total Split (%)	77.5%	68.8%	68.8%	77.5%	68.8%	13.8%	22.5%	13.8%	13.8%	22.5%	13.8%	9%
Yellow Time (s)	4.0	4.0	4.0	4.0	4.0	4.0	4.0	4.0	4.0	4.0	4.0	2.0
All-Red Time (s)	1.0	1.0	1.0	1.0	1.0	2.0	2.0	2.0	2.0	2.0	2.0	0.0
Lost Time Adjust (s)	-2.0	-2.0		-2.0	-2.0		-2.0	-2.0		-2.0	-2.0	
Total Lost Time (s)	3.0	3.0		3.0	3.0		4.0	4.0		4.0	4.0	
Lead/Lag		Lag	Lag		Lag	Lag		Lag	Lag		Lag	Lead
Lead-Lag Optimize?												
Recall Mode	C-Max	C-Max	C-Max	C-Max	C-Max	Max	Max	Max	Max	Max	Max	Max

Intersection Summary

Cycle Length: 80  
 Actuated Cycle Length: 80  
 Offset: 39 (49%), Referenced to phase 2:WBL and 6:EBWB, Start of Green  
 Natural Cycle: 70  
 Control Type: Actuated-Coordinated

Splits and Phases: 5: Montmorency & St-Patrick

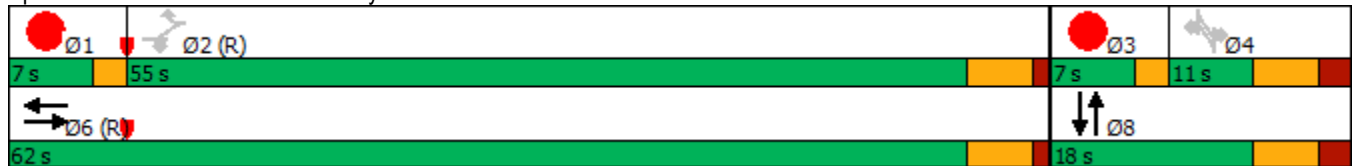

Lane Group	Ø3
Lane Configurations	
Traffic Volume (vph)	
Future Volume (vph)	
Turn Type	
Protected Phases	3
Permitted Phases	
Detector Phase	
Switch Phase	
Minimum Initial (s)	3.0
Minimum Split (s)	7.0
Total Split (s)	7.0
Total Split (%)	9%
Yellow Time (s)	2.0
All-Red Time (s)	0.0
Lost Time Adjust (s)	
Total Lost Time (s)	
Lead/Lag	Lead
Lead-Lag Optimize?	
Recall Mode	Max
Intersection Summary	



Lane Group	EBT	EBR	WBL	WBT	WBR	NBL	NBT	NBR	SBL	SBT	SBR	Ø1
Lane Configurations	↑	↗		↕	↗		↖	↗		↕	↗	
Traffic Volume (vph)	640	27	42	234	3	29	0	50	8	0	4	
Future Volume (vph)	656	124	81	238	3	305	0	220	8	0	4	
Turn Type	NA	custom	custom	NA	custom	custom	NA	custom	custom	NA	custom	
Protected Phases	6			6			8			8		1
Permitted Phases		2	2		2	4		4	4		4	
Detector Phase												
Switch Phase												
Minimum Initial (s)	5.0	5.0	5.0	5.0	5.0	5.0	5.0	5.0	5.0	5.0	5.0	5.0
Minimum Split (s)	43.0	16.0	16.0	43.0	16.0	11.0	11.0	11.0	11.0	11.0	11.0	7.0
Total Split (s)	50.0	43.0	43.0	50.0	43.0	23.0	30.0	23.0	23.0	30.0	23.0	7.0
Total Split (%)	62.5%	53.8%	53.8%	62.5%	53.8%	28.8%	37.5%	28.8%	28.8%	37.5%	28.8%	9%
Yellow Time (s)	4.0	4.0	4.0	4.0	4.0	4.0	4.0	4.0	4.0	4.0	4.0	2.0
All-Red Time (s)	1.0	1.0	1.0	1.0	1.0	2.0	2.0	2.0	2.0	2.0	2.0	0.0
Lost Time Adjust (s)	-2.0	-2.0		-2.0	-2.0		-2.0	-2.0		-2.0	-2.0	
Total Lost Time (s)	3.0	3.0		3.0	3.0		4.0	4.0		4.0	4.0	
Lead/Lag		Lag	Lag		Lag	Lag		Lag	Lag		Lag	Lead
Lead-Lag Optimize?												
Recall Mode	C-Max	C-Max	C-Max	C-Max	C-Max	Max	Max	Max	Max	Max	Max	Max

Intersection Summary

Cycle Length: 80  
 Actuated Cycle Length: 80  
 Offset: 57 (71%), Referenced to phase 2:WBL and 6:EBWB, Start of Green  
 Natural Cycle: 65  
 Control Type: Actuated-Coordinated

Splits and Phases: 5: Montmorency & St-Patrick





Lane Group	Ø3
Lane Configurations	
Traffic Volume (vph)	
Future Volume (vph)	
Turn Type	
Protected Phases	3
Permitted Phases	
Detector Phase	
Switch Phase	
Minimum Initial (s)	3.0
Minimum Split (s)	7.0
Total Split (s)	7.0
Total Split (%)	9%
Yellow Time (s)	2.0
All-Red Time (s)	0.0
Lost Time Adjust (s)	
Total Lost Time (s)	
Lead/Lag	Lead
Lead-Lag Optimize?	
Recall Mode	Max
Intersection Summary	



Lane Group	EBL	EBT	WBT	WBR	NBL	NBT	SBL	SBT	SBR	Ø3	Ø6
Lane Configurations		↕↕	↕	↕		↕		↕	↕		
Traffic Volume (vph)	151	183	227	391	1	0	70	2	36		
Future Volume (vph)	151	454	262	402	1	0	132	2	36		
Turn Type	D.P+P	NA	NA	Perm	Perm	NA	Perm	NA	pm+ov		
Protected Phases	1	1 2	2			4		4	1	3	6
Permitted Phases	2			2	4		4		4		
Detector Phase							4	4	4		
Switch Phase											
Minimum Initial (s)	6.0		10.0	10.0	12.0	12.0	12.0	12.0	6.0	11.0	11.0
Minimum Split (s)	10.0		22.0	22.0	18.0	18.0	18.0	18.0	10.0	22.0	22.0
Total Split (s)	20.0		30.0	30.0	18.0	18.0	18.0	18.0	20.0	22.0	50.0
Total Split (%)	22.2%		33.3%	33.3%	20.0%	20.0%	20.0%	20.0%	22.2%	24%	56%
Yellow Time (s)	4.0		4.0	4.0	4.0	4.0	4.0	4.0	4.0	2.0	4.0
All-Red Time (s)	0.0		1.0	1.0	2.0	2.0	2.0	2.0	0.0	1.0	1.0
Lost Time Adjust (s)			-2.0	-2.0		-2.0		-2.0	-2.0		
Total Lost Time (s)			3.0	3.0		4.0		4.0	2.0		
Lead/Lag	Lead		Lag	Lag					Lead		
Lead-Lag Optimize?			Yes	Yes							
Recall Mode	Max		Max	Max	Min	Min	Min	Min	Max	None	Max

Intersection Summary

Cycle Length: 90  
 Actuated Cycle Length: 72.4  
 Natural Cycle: 75  
 Control Type: Semi Act-Uncoord

Splits and Phases: 2: des Seigneurs & St-Patrick

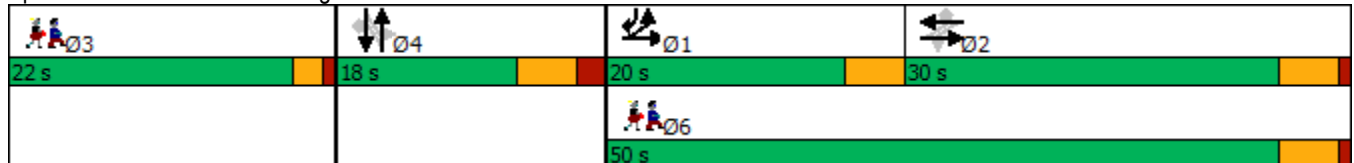



Lane Group	EBL	EBT	WBL	WBT	WBR	NBL	NBT	SBL	SBT	SBR	Ø3
Lane Configurations		↕↕		↕	↕		↕↕		↕	↕	
Traffic Volume (vph)	110	422	7	236	116	3	7	366	5	113	
Future Volume (vph)	110	497	7	448	203	3	7	398	5	113	
Turn Type	pm+pt	NA	Perm	NA	Perm	Perm	NA	Perm	NA	pm+ov	
Protected Phases	1	6		2			4		4	1	3
Permitted Phases	6		2		2	4		4		4	
Detector Phase								4	4	4	
Switch Phase											
Minimum Initial (s)	4.0	11.0	10.0	10.0	10.0	12.0	12.0	12.0	12.0	4.0	8.0
Minimum Split (s)	8.0	43.0	22.0	22.0	22.0	18.0	18.0	18.0	18.0	8.0	19.0
Total Split (s)	20.0	51.0	31.0	31.0	31.0	35.0	35.0	35.0	35.0	20.0	19.0
Total Split (%)	19.0%	48.6%	29.5%	29.5%	29.5%	33.3%	33.3%	33.3%	33.3%	19.0%	18%
Yellow Time (s)	4.0	4.0	4.0	4.0	4.0	4.0	4.0	4.0	4.0	4.0	2.0
All-Red Time (s)	0.0	1.0	1.0	1.0	1.0	2.0	2.0	2.0	2.0	0.0	1.0
Lost Time Adjust (s)		-2.0		-2.0	-2.0		-2.0		-2.0	-2.0	
Total Lost Time (s)		3.0		3.0	3.0		4.0		4.0	2.0	
Lead/Lag	Lead		Lag	Lag	Lag						Lead
Lead-Lag Optimize?											
Recall Mode	Max	Max	Max	Max	Max	Min	Min	Min	Min	Max	None

Intersection Summary

Cycle Length: 105  
 Actuated Cycle Length: 89.8  
 Natural Cycle: 90  
 Control Type: Semi Act-Uncoord

Splits and Phases: 2: des Seigneurs & St-Patrick

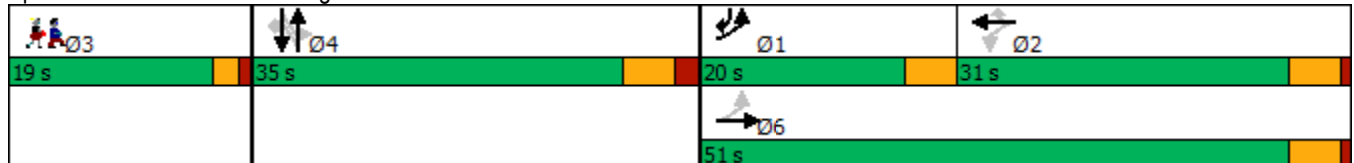

**1: rue St-Patrick & rue Charlevoix Performance by approach**

Approach	EB	WB	NB	SB	All
Denied Delay (hr)	0.2	0.0	5.9	0.0	6.1
Denied Del/Veh (s)	1.1	0.0	54.5	0.2	11.6
Total Delay (hr)	30.9	2.0	17.0	2.6	52.6
Total Del/Veh (s)	155.7	12.6	158.3	37.3	97.7
Vehicles Entered	682	579	374	243	1878
Vehicles Exited	650	581	371	240	1842
Hourly Exit Rate	650	581	371	240	1842
Input Volume	682	602	390	241	1915
% of Volume	95	97	95	100	96

**2: des Seigneurs & St-Patrick Performance by approach**

Approach	EB	WB	NB	SB	All
Denied Delay (hr)	0.8	0.4	0.0	0.2	1.4
Denied Del/Veh (s)	5.0	2.2	0.1	1.2	2.8
Total Delay (hr)	13.0	7.9	0.1	8.0	28.9
Total Del/Veh (s)	78.6	40.6	22.6	55.9	57.2
Vehicles Entered	579	683	16	502	1780
Vehicles Exited	578	689	16	496	1779
Hourly Exit Rate	578	689	16	496	1779
Input Volume	607	691	13	512	1823
% of Volume	95	100	123	97	98

**3: Shearer/Accès & St-Patrick Performance by approach**

Approach	EB	WB	NB	All
Denied Delay (hr)	0.1	0.6	0.3	1.0
Denied Del/Veh (s)	0.4	3.3	11.8	2.2
Total Delay (hr)	0.5	3.7	2.7	6.8
Total Del/Veh (s)	1.7	20.9	91.8	14.4
Vehicles Entered	959	632	103	1694
Vehicles Exited	960	626	99	1685
Hourly Exit Rate	960	626	99	1685
Input Volume	985	623	111	1719
% of Volume	97	100	89	98

---

**4: St-Patrick Performance by approach**

---

Approach	EB	WB	NB	All
Denied Delay (hr)	0.0	0.0	0.0	0.0
Denied Del/Veh (s)	0.0	0.1	0.0	0.0
Total Delay (hr)	1.6	0.5	0.8	2.9
Total Del/Veh (s)	7.0	3.2	42.7	7.0
Vehicles Entered	821	584	64	1469
Vehicles Exited	823	583	60	1466
Hourly Exit Rate	823	583	60	1466
Input Volume	840	582	56	1478
% of Volume	98	100	107	99

---

**5: Montmorency & St-Patrick Performance by approach**

---

Approach	EB	WB	NB	SB	All
Denied Delay (hr)	1.6	0.0	0.6	0.0	2.3
Denied Del/Veh (s)	8.0	0.3	4.6	0.1	5.2
Total Delay (hr)	4.7	4.5	4.4	0.1	13.7
Total Del/Veh (s)	23.1	44.6	30.0	38.7	30.2
Vehicles Entered	738	361	514	10	1623
Vehicles Exited	732	357	515	10	1614
Hourly Exit Rate	732	357	515	10	1614
Input Volume	766	360	516	12	1654
% of Volume	96	99	100	83	98

---

**6: Rue Bridge & Rue Saint-Patrick Performance by approach**

---

Approach	EB	WB	NB	All
Denied Delay (hr)	18.5	0.0	0.0	18.5
Denied Del/Veh (s)	65.0	0.0	0.1	44.9
Total Delay (hr)	14.8	0.5	1.3	16.6
Total Del/Veh (s)	53.3	8.4	18.6	40.8
Vehicles Entered	992	215	245	1452
Vehicles Exited	977	215	244	1436
Hourly Exit Rate	977	215	244	1436
Input Volume	1071	214	241	1526
% of Volume	91	100	101	94

**7: Rue Wellington & Rue Saint-Patrick Performance by approach**

Approach	EB	NB	SB	All
Denied Delay (hr)	0.0	0.0	0.2	0.2
Denied Del/Veh (s)	0.0	0.0	0.7	0.4
Total Delay (hr)	4.0	0.7	4.9	9.6
Total Del/Veh (s)	42.5	7.9	15.4	19.3
Vehicles Entered	338	297	1138	1773
Vehicles Exited	336	294	1137	1767
Hourly Exit Rate	336	294	1137	1767
Input Volume	375	336	1138	1849
% of Volume	90	88	100	96

**8: rue Charlevoix & Rue Centre Performance by approach**

Approach	EB	WB	NB	SB	All
Denied Delay (hr)	0.0	0.0	0.0	0.0	0.1
Denied Del/Veh (s)	0.3	0.0	0.3	0.0	0.2
Total Delay (hr)	5.0	0.9	6.5	0.5	12.9
Total Del/Veh (s)	50.8	25.6	89.6	11.4	51.5
Vehicles Entered	348	122	256	160	886
Vehicles Exited	338	121	252	160	871
Hourly Exit Rate	338	121	252	160	871
Input Volume	343	127	256	160	886
% of Volume	99	95	98	100	98

**9: rue Sucrierie Performance by approach**

Approach	EB	NB	SB	All
Denied Delay (hr)	0.0	0.0	0.0	0.0
Denied Del/Veh (s)	0.0	0.0	0.0	0.0
Total Delay (hr)	0.1	0.0	0.0	0.1
Total Del/Veh (s)	4.3	2.6	0.3	2.6
Vehicles Entered	74	29	59	162
Vehicles Exited	74	29	58	161
Hourly Exit Rate	74	29	58	161
Input Volume	65	33	61	159
% of Volume	114	88	95	101

---

**10: Montmorency Performance by approach**

---

Approach	EB	NB	SB	All
Denied Delay (hr)	7.5	0.0	0.0	7.5
Denied Del/Veh (s)	153.1	0.0	0.0	39.9
Total Delay (hr)	3.9	1.5	0.0	5.4
Total Del/Veh (s)	84.4	19.0	0.5	29.1
Vehicles Entered	162	284	218	664
Vehicles Exited	161	283	217	661
Hourly Exit Rate	161	283	217	661
Input Volume	165	280	219	664
% of Volume	98	101	99	100

---

**11: Montmorency Performance by approach**

---

Approach	EB	NB	SB	All
Denied Delay (hr)	0.1	0.0	0.0	0.1
Denied Del/Veh (s)	0.6	0.0	0.0	0.4
Total Delay (hr)	0.5	0.1	0.0	0.6
Total Del/Veh (s)	5.7	2.8	0.4	3.8
Vehicles Entered	349	72	178	599
Vehicles Exited	348	72	178	598
Hourly Exit Rate	348	72	178	598
Input Volume	352	69	181	602
% of Volume	99	104	98	99

---

**12: Shearer & Centre Performance by approach**

---

Approach	EB	WB	NB	SB	All
Denied Delay (hr)	0.0	0.0	0.0	0.0	0.0
Denied Del/Veh (s)	0.0	0.0	0.1	0.2	0.1
Total Delay (hr)	0.3	0.2	0.2	0.7	1.3
Total Del/Veh (s)	4.7	7.8	12.6	15.1	9.3
Vehicles Entered	211	81	45	161	498
Vehicles Exited	211	81	45	163	500
Hourly Exit Rate	211	81	45	163	500
Input Volume	220	87	47	178	532
% of Volume	96	93	96	92	94

**13: rue Sucrierie & Centre Performance by approach**

Approach	EB	WB	NB	SB	All
Denied Delay (hr)	0.0	0.0	0.0	0.0	0.0
Denied Del/Veh (s)	0.0	0.0	0.1	0.1	0.1
Total Delay (hr)	0.8	0.1	0.2	0.4	1.5
Total Del/Veh (s)	15.5	5.1	13.8	14.6	13.0
Vehicles Entered	197	88	42	99	426
Vehicles Exited	196	88	42	98	424
Hourly Exit Rate	196	88	42	98	424
Input Volume	211	94	42	102	449
% of Volume	93	94	100	96	94

**14: rue Centre/Centre Performance by approach**

Approach	EB	WB	SB	All
Denied Delay (hr)	0.0	0.0	0.2	0.2
Denied Del/Veh (s)	0.0	0.1	11.8	1.7
Total Delay (hr)	0.7	0.0	0.8	1.6
Total Del/Veh (s)	10.1	0.5	43.9	12.0
Vehicles Entered	254	150	69	473
Vehicles Exited	254	150	68	472
Hourly Exit Rate	254	150	68	472
Input Volume	260	157	69	486
% of Volume	98	96	99	97

**15: Rue Wellington & rue Centre/Accès Performance by approach**

Approach	EB	WB	NB	SB	All
Denied Delay (hr)	11.3	0.0	0.0	0.0	11.3
Denied Del/Veh (s)	145.5	0.1	0.0	0.1	47.9
Total Delay (hr)	9.7	0.3	4.2	0.4	14.6
Total Del/Veh (s)	137.4	276.9	42.2	6.4	63.7
Vehicles Entered	249	5	358	208	820
Vehicles Exited	237	3	348	207	795
Hourly Exit Rate	237	3	348	207	795
Input Volume	284	4	368	210	866
% of Volume	83	75	95	99	92



**16: Shearer & Richardson Performance by approach**

Approach	WB	NB	SB	All
Denied Delay (hr)	0.0	0.0	0.0	0.0
Denied Del/Veh (s)	0.0	0.0	0.0	0.0
Total Delay (hr)	0.1	0.0	0.0	0.1
Total Del/Veh (s)	3.5	0.8	0.5	1.4
Vehicles Entered	61	46	120	227
Vehicles Exited	61	46	121	228
Hourly Exit Rate	61	46	121	228
Input Volume	66	47	123	236
% of Volume	92	98	98	97

**17: rue Sucrierie & Richardson Performance by approach**

Approach	WB	NB	SB	All
Denied Delay (hr)	0.0	0.0	0.0	0.0
Denied Del/Veh (s)	0.0	0.0	0.0	0.0
Total Delay (hr)	0.1	0.0	0.0	0.2
Total Del/Veh (s)	4.8	4.7	3.0	4.6
Vehicles Entered	80	33	10	123
Vehicles Exited	80	33	10	123
Hourly Exit Rate	80	33	10	123
Input Volume	83	40	8	131
% of Volume	96	82	125	94

**18: Richardson & Montmorency Performance by approach**

Approach	WB	NB	SB	All
Denied Delay (hr)	0.0	0.0	0.0	0.0
Denied Del/Veh (s)	0.1	0.0	0.0	0.0
Total Delay (hr)	0.0	0.1	0.1	0.2
Total Del/Veh (s)	4.3	3.8	2.0	2.8
Vehicles Entered	22	86	154	262
Vehicles Exited	22	87	154	263
Hourly Exit Rate	22	87	154	263
Input Volume	21	84	161	266
% of Volume	105	104	96	99

---

**19: rue de la Prairie & Rue Centre Performance by approach**

---

Approach	EB	WB	All
Denied Delay (hr)	0.0	0.0	0.0
Denied Del/Veh (s)	0.0	0.1	0.0
Total Delay (hr)	0.4	0.2	0.7
Total Del/Veh (s)	6.8	6.4	6.7
Vehicles Entered	234	123	357
Vehicles Exited	234	123	357
Hourly Exit Rate	234	123	357
Input Volume	244	127	371
% of Volume	96	97	96

---

**20: Rue Bridge & Rue Wellington Performance by approach**

---

Approach	EB	WB	NB	SB	All
Denied Delay (hr)	2.5	0.0	0.0	0.1	2.5
Denied Del/Veh (s)	14.6	0.0	0.1	0.4	3.7
Total Delay (hr)	27.8	9.2	6.5	29.4	72.9
Total Del/Veh (s)	159.5	33.5	69.5	174.0	102.5
Vehicles Entered	603	985	320	587	2495
Vehicles Exited	587	971	325	578	2461
Hourly Exit Rate	587	971	325	578	2461
Input Volume	672	993	326	642	2633
% of Volume	87	98	100	90	93

---

**21: Rue Ropery & Rue Centre Performance by approach**

---

Approach	EB	WB	All
Denied Delay (hr)	0.0	0.0	0.0
Denied Del/Veh (s)	0.0	0.0	0.0
Total Delay (hr)	0.6	0.6	1.2
Total Del/Veh (s)	9.1	17.7	12.0
Vehicles Entered	238	123	361
Vehicles Exited	238	122	360
Hourly Exit Rate	238	122	360
Input Volume	248	127	375
% of Volume	96	96	96

**23: Rue Island & Rue Centre Performance by approach**

Approach	EB	WB	NB	All
Denied Delay (hr)	0.0	0.0	0.0	0.0
Denied Del/Veh (s)	0.0	0.0	0.1	0.0
Total Delay (hr)	1.1	0.4	0.2	1.7
Total Del/Veh (s)	17.6	14.5	12.1	16.0
Vehicles Entered	220	107	51	378
Vehicles Exited	219	108	51	378
Hourly Exit Rate	219	108	51	378
Input Volume	233	112	49	394
% of Volume	94	96	104	96

**40: Performance by approach**

Approach	NB	All
Denied Delay (hr)	0.0	0.0
Denied Del/Veh (s)	0.0	0.0
Total Delay (hr)	0.0	0.0
Total Del/Veh (s)	0.8	0.8
Vehicles Entered	47	47
Vehicles Exited	47	47
Hourly Exit Rate	47	47
Input Volume	49	49
% of Volume	96	96

**45: St-Patrick/Rue Saint-Patrick Performance by approach**

Approach	EB	WB	NB	SB	All
Denied Delay (hr)	0.2	0.0	0.0	0.0	0.3
Denied Del/Veh (s)	1.6	0.0	2.0	0.1	0.8
Total Delay (hr)	3.3	2.3	0.1	0.0	5.8
Total Del/Veh (s)	22.6	15.1	6.5	4.7	18.0
Vehicles Entered	525	551	68	7	1151
Vehicles Exited	527	544	68	7	1146
Hourly Exit Rate	527	544	68	7	1146
Input Volume	556	563	69	8	1196
% of Volume	95	97	99	88	96

48: Performance by approach

Approach	EB	WB	NB	All
Denied Delay (hr)	0.0	0.0	0.0	0.0
Denied Del/Veh (s)	0.2	0.0	0.1	0.1
Total Delay (hr)	0.1	0.2	0.0	0.3
Total Del/Veh (s)	8.7	7.4	4.7	7.6
Vehicles Entered	56	90	18	164
Vehicles Exited	56	90	18	164
Hourly Exit Rate	56	90	18	164
Input Volume	49	96	16	161
% of Volume	114	94	112	102

Total Network Performance

Denied Delay (hr)	51.7
Denied Del/Veh (s)	30.2
Total Delay (hr)	258.4
Total Del/Veh (s)	145.6
Vehicles Entered	6046
Vehicles Exited	5867
Hourly Exit Rate	5867
Input Volume	28559
% of Volume	21

**Intersection: 1: rue St-Patrick & rue Charlevoix**

Movement	EB	EB	WB	WB	NB	NB	SB	SB
Directions Served	LT	R	LT	R	LT	R	LT	R
Maximum Queue (m)	500.2	37.5	85.2	37.5	204.8	14.5	77.0	18.2
Average Queue (m)	297.9	16.9	39.1	15.8	156.0	6.6	37.8	12.5
95th Queue (m)	566.8	45.6	71.7	39.2	259.2	16.5	64.4	19.5
Link Distance (m)	698.5		365.4		213.9		893.1	
Upstream Blk Time (%)	1				17			
Queuing Penalty (veh)	0				61			
Storage Bay Dist (m)		30.0		30.0		7.0		7.0
Storage Blk Time (%)	65	0	12	0	77	8	58	29
Queuing Penalty (veh)	24	1	13	1	20	28	45	48

**Intersection: 2: des Seigneurs & St-Patrick**

Movement	EB	EB	WB	WB	NB	SB	SB
Directions Served	LT	TR	LT	R	LTR	LT	R
Maximum Queue (m)	163.7	67.5	68.2	64.0	14.2	188.4	17.5
Average Queue (m)	127.9	56.7	63.4	34.2	3.1	98.7	13.5
95th Queue (m)	192.9	93.2	74.1	58.7	10.8	185.3	23.1
Link Distance (m)	159.4		57.6	57.6	57.0	294.2	
Upstream Blk Time (%)	10		37	3			
Queuing Penalty (veh)	58		119	9			
Storage Bay Dist (m)		60.0					10.0
Storage Blk Time (%)	57	4				60	2
Queuing Penalty (veh)	142	14				67	6

**Intersection: 3: Shearer/Accès & St-Patrick**

Movement	EB	EB	WB	NB	NB
Directions Served	LT	R	LTR	LT	R
Maximum Queue (m)	51.4	14.0	138.8	82.5	22.5
Average Queue (m)	5.5	0.7	59.9	26.6	11.6
95th Queue (m)	29.8	5.6	132.1	74.0	26.0
Link Distance (m)	57.6	57.6	141.4	164.9	
Upstream Blk Time (%)	1		2		
Queuing Penalty (veh)	4		10		
Storage Bay Dist (m)					15.0
Storage Blk Time (%)				38	2
Queuing Penalty (veh)				21	1

**Intersection: 4: St-Patrick**

Movement	EB	WB	NB
Directions Served	TR	LT	LR
Maximum Queue (m)	100.5	70.4	45.8
Average Queue (m)	24.3	10.0	13.3
95th Queue (m)	94.1	40.1	31.3
Link Distance (m)	141.4	93.5	72.9
Upstream Blk Time (%)	1		0
Queuing Penalty (veh)	8		0
Storage Bay Dist (m)			
Storage Blk Time (%)			
Queuing Penalty (veh)			

**Intersection: 5: Montmorency & St-Patrick**

Movement	EB	EB	WB	NB	NB	SB
Directions Served	T	R	LTR	LT	R	LTR
Maximum Queue (m)	98.1	22.5	134.7	29.5	28.8	12.5
Average Queue (m)	78.0	13.3	60.2	26.7	25.5	2.5
95th Queue (m)	111.0	28.4	127.1	32.0	31.8	8.7
Link Distance (m)	93.5		196.1	25.4	25.4	55.0
Upstream Blk Time (%)	10		0	36	34	
Queuing Penalty (veh)	67		0	81	75	
Storage Bay Dist (m)		15.0				
Storage Blk Time (%)	41	7	56			10
Queuing Penalty (veh)	50	43	1			0

**Intersection: 6: Rue Bridge & Rue Saint-Patrick**

Movement	EB	EB	WB	WB	NB	NB
Directions Served	LT	R	L	T	L	TR
Maximum Queue (m)	181.1	191.8	2.3	23.9	71.3	9.0
Average Queue (m)	70.4	124.0	0.2	8.1	24.5	0.5
95th Queue (m)	163.5	231.6	1.3	20.2	58.4	3.9
Link Distance (m)	196.1	196.1	225.7	225.7	148.6	148.6
Upstream Blk Time (%)	1	7				
Queuing Penalty (veh)	6	31				
Storage Bay Dist (m)						
Storage Blk Time (%)						
Queuing Penalty (veh)						

**Intersection: 7: Rue Wellington & Rue Saint-Patrick**

Movement	EB	EB	NB	NB	SB	SB	SB
Directions Served	L	R	LT	T	T	T	R
Maximum Queue (m)	78.7	19.4	36.1	43.1	85.0	91.3	9.3
Average Queue (m)	45.7	6.0	9.6	11.6	51.2	56.2	8.9
95th Queue (m)	71.4	15.3	27.4	31.5	74.4	82.8	9.5
Link Distance (m)	225.7	225.7	167.6	167.6	260.1	260.1	
Upstream Blk Time (%)							
Queuing Penalty (veh)							
Storage Bay Dist (m)							0.1
Storage Blk Time (%)						24	19
Queuing Penalty (veh)						50	86

**Intersection: 8: rue Charlevoix & Rue Centre**

Movement	EB	WB	NB	SB
Directions Served	LTR	LTR	LTR	LTR
Maximum Queue (m)	138.6	54.3	136.8	39.8
Average Queue (m)	62.7	22.7	68.4	15.4
95th Queue (m)	140.5	43.0	177.4	30.9
Link Distance (m)	664.8	218.4	403.6	213.9
Upstream Blk Time (%)				
Queuing Penalty (veh)				
Storage Bay Dist (m)				
Storage Blk Time (%)	58	37		
Queuing Penalty (veh)	10	8		

**Intersection: 9: rue Sucrierie**

Movement	EB	NB
Directions Served	LR	LT
Maximum Queue (m)	18.1	8.5
Average Queue (m)	9.2	0.6
95th Queue (m)	15.8	4.3
Link Distance (m)	29.7	82.6
Upstream Blk Time (%)	0	
Queuing Penalty (veh)	0	
Storage Bay Dist (m)		
Storage Blk Time (%)		
Queuing Penalty (veh)		

Intersection: 10: Montmorency

Movement	EB	NB	SB
Directions Served	LR	LT	T
Maximum Queue (m)	40.5	66.7	6.6
Average Queue (m)	33.0	29.5	0.2
95th Queue (m)	51.5	59.9	2.1
Link Distance (m)	35.9	80.8	25.4
Upstream Blk Time (%)	57	1	
Queuing Penalty (veh)	0	2	
Storage Bay Dist (m)			
Storage Blk Time (%)			
Queuing Penalty (veh)			

Intersection: 11: Montmorency

Movement	EB	NB	SB
Directions Served	LR	LT	TR
Maximum Queue (m)	31.6	12.0	1.4
Average Queue (m)	22.3	3.3	0.0
95th Queue (m)	33.1	10.9	1.0
Link Distance (m)	27.0	35.8	80.8
Upstream Blk Time (%)	4		
Queuing Penalty (veh)	0		
Storage Bay Dist (m)			
Storage Blk Time (%)			
Queuing Penalty (veh)			

Intersection: 12: Shearer & Centre

Movement	EB	EB	WB	WB	NB	SB
Directions Served	LT	R	LT	R	LTR	LTR
Maximum Queue (m)	22.9	9.2	27.4	9.6	19.3	43.4
Average Queue (m)	5.1	0.8	7.6	0.7	6.0	19.1
95th Queue (m)	15.3	4.9	19.3	4.9	14.5	34.9
Link Distance (m)	231.8		136.3		152.8	73.8
Upstream Blk Time (%)						
Queuing Penalty (veh)						
Storage Bay Dist (m)		15.0		15.0		
Storage Blk Time (%)	2	0	4		12	35
Queuing Penalty (veh)	0	0	0		0	3



**Intersection: 13: rue Sucrierie & Centre**

Movement	EB	WB	WB	NB	SB
Directions Served	LTR	LT	R	LTR	LTR
Maximum Queue (m)	48.4	20.0	7.3	16.0	26.7
Average Queue (m)	20.8	5.0	1.1	5.4	12.0
95th Queue (m)	39.2	14.1	5.2	13.7	24.0
Link Distance (m)	136.3	99.5		156.3	73.1
Upstream Blk Time (%)					
Queuing Penalty (veh)					
Storage Bay Dist (m)			15.0		
Storage Blk Time (%)	32	1		13	24
Queuing Penalty (veh)	3	0		2	4

**Intersection: 14: rue Centre/Centre**

Movement	EB	SB
Directions Served	LT	LR
Maximum Queue (m)	36.2	29.9
Average Queue (m)	7.3	13.8
95th Queue (m)	38.0	37.8
Link Distance (m)	99.5	72.5
Upstream Blk Time (%)	1	1
Queuing Penalty (veh)	3	0
Storage Bay Dist (m)		
Storage Blk Time (%)		
Queuing Penalty (veh)		

**Intersection: 15: Rue Wellington & rue Centre/Accès**

Movement	EB	WB	NB	NB	B37	SB	SB
Directions Served	LTR	LTR	LT	TR	T	LT	TR
Maximum Queue (m)	144.1	36.5	77.2	74.4	63.3	42.5	29.5
Average Queue (m)	90.4	6.1	31.7	31.1	4.1	11.8	7.5
95th Queue (m)	176.4	26.4	75.3	68.8	40.4	27.8	21.0
Link Distance (m)	167.7	202.8	78.0	78.0	296.5	178.0	178.0
Upstream Blk Time (%)	12		5	2			
Queuing Penalty (veh)	21		0	0			
Storage Bay Dist (m)							
Storage Blk Time (%)							
Queuing Penalty (veh)							

**Intersection: 16: Shearer & Richardson**

Movement	WB	SB
Directions Served	LTR	TR
Maximum Queue (m)	14.6	1.8
Average Queue (m)	7.0	0.1
95th Queue (m)	14.1	1.4
Link Distance (m)	145.7	164.9
Upstream Blk Time (%)		
Queuing Penalty (veh)		
Storage Bay Dist (m)		
Storage Blk Time (%)		
Queuing Penalty (veh)		

**Intersection: 17: rue Sucrierie & Richardson**

Movement	WB	NB	SB
Directions Served	LTR	LT	TR
Maximum Queue (m)	15.2	11.7	9.2
Average Queue (m)	9.1	6.4	1.8
95th Queue (m)	12.8	13.3	7.7
Link Distance (m)	96.0	73.1	82.6
Upstream Blk Time (%)			
Queuing Penalty (veh)			
Storage Bay Dist (m)			
Storage Blk Time (%)			
Queuing Penalty (veh)			

**Intersection: 18: Richardson & Montmorency**

Movement	WB	NB	SB
Directions Served	LTR	LT	TR
Maximum Queue (m)	12.1	13.6	13.3
Average Queue (m)	5.2	8.5	8.4
95th Queue (m)	13.0	12.9	13.2
Link Distance (m)	197.6	72.5	35.8
Upstream Blk Time (%)			
Queuing Penalty (veh)			
Storage Bay Dist (m)			
Storage Blk Time (%)			
Queuing Penalty (veh)			

Intersection: 19: rue de la Prairie & Rue Centre

Movement	EB	WB
Directions Served	LTR	LTR
Maximum Queue (m)	32.3	22.8
Average Queue (m)	13.7	9.2
95th Queue (m)	28.0	19.2
Link Distance (m)	127.7	127.0
Upstream Blk Time (%)		
Queuing Penalty (veh)		
Storage Bay Dist (m)		
Storage Blk Time (%)		
Queuing Penalty (veh)		

Intersection: 20: Rue Bridge & Rue Wellington

Movement	EB	EB	WB	WB	WB	NB	NB	NB	SB	SB
Directions Served	T	R	L	LT	TR	LT	TR	R	LT	TR
Maximum Queue (m)	185.5	186.7	126.8	128.7	84.0	88.7	89.6	46.1	149.1	167.2
Average Queue (m)	138.5	146.7	70.9	72.5	25.6	53.0	33.8	9.4	125.2	138.9
95th Queue (m)	221.1	223.9	114.1	116.2	70.2	87.0	77.2	32.7	185.0	205.5
Link Distance (m)	178.0	178.0	167.6	167.6		697.0	697.0		148.6	148.6
Upstream Blk Time (%)	20	31							1	32
Queuing Penalty (veh)	64	101							3	102
Storage Bay Dist (m)					70.0			60.0		
Storage Blk Time (%)				11	0		3			
Queuing Penalty (veh)				5	0		1			

Intersection: 21: Rue Ropery & Rue Centre

Movement	EB	WB
Directions Served	LT	LT
Maximum Queue (m)	33.7	41.5
Average Queue (m)	15.5	21.1
95th Queue (m)	29.7	36.6
Link Distance (m)	218.4	127.7
Upstream Blk Time (%)		
Queuing Penalty (veh)		
Storage Bay Dist (m)		
Storage Blk Time (%)	13	2
Queuing Penalty (veh)	0	0

**Intersection: 23: Rue Island & Rue Centre**

Movement	EB	WB	NB
Directions Served	LT	TR	LTR
Maximum Queue (m)	47.8	34.8	23.8
Average Queue (m)	24.6	14.9	7.5
95th Queue (m)	43.0	28.5	19.0
Link Distance (m)	127.0	231.8	155.4
Upstream Blk Time (%)			
Queuing Penalty (veh)			
Storage Bay Dist (m)			
Storage Blk Time (%)			13
Queuing Penalty (veh)			1

**Intersection: 40:**

Movement
Directions Served
Maximum Queue (m)
Average Queue (m)
95th Queue (m)
Link Distance (m)
Upstream Blk Time (%)
Queuing Penalty (veh)
Storage Bay Dist (m)
Storage Blk Time (%)
Queuing Penalty (veh)

**Intersection: 45: St-Patrick/Rue Saint-Patrick**

Movement	EB	B39	WB	NB	NB	SB	SB
Directions Served	LT	T	TR	LT	R	L	R
Maximum Queue (m)	116.6	14.0	68.2	13.2	14.2	9.1	9.1
Average Queue (m)	45.7	0.6	45.6	6.7	7.8	1.2	0.7
95th Queue (m)	106.4	9.4	65.0	13.7	17.3	6.3	4.7
Link Distance (m)	158.1	365.4	159.4			57.2	57.2
Upstream Blk Time (%)	2						
Queuing Penalty (veh)	8						
Storage Bay Dist (m)					10.0		
Storage Blk Time (%)				4	5		
Queuing Penalty (veh)				1	2		

Intersection: 48:

Movement	EB	WB	NB
Directions Served	T	LT	R
Maximum Queue (m)	18.8	25.5	6.7
Average Queue (m)	7.1	9.9	1.4
95th Queue (m)	16.5	21.2	5.7
Link Distance (m)	14.7	29.7	31.2
Upstream Blk Time (%)	2	0	
Queuing Penalty (veh)	0	0	
Storage Bay Dist (m)			
Storage Blk Time (%)			
Queuing Penalty (veh)			

Network Summary

Network wide Queuing Penalty: 1535

1: rue St-Patrick & rue Charlevoix Performance by movement

Movement	EBL	EBT	EBR	WBL	WBT	WBR	NBL	NBT	NBR	SBL	SBT	SBR
Denied Delay (hr)	0.1	0.1	0.0	0.0	0.0	0.0	2.1	3.4	0.4	0.0	0.0	0.0
Denied Del/Veh (s)	0.9	1.1	1.7	0.0	0.0	0.0	61.0	50.7	60.2	0.2	0.2	0.2
Total Delay (hr)	9.6	19.7	1.6	0.0	1.6	0.4	5.4	10.6	1.1	0.6	1.2	0.8
Total Del/Veh (s)	156.2	157.6	133.4	18.2	12.2	13.9	158.0	158.3	160.3	40.1	37.2	36.3
Vehicles Entered	210	432	40	5	474	100	118	233	23	50	117	76
Vehicles Exited	203	409	38	5	476	100	118	229	24	48	117	75
Hourly Exit Rate	203	409	38	5	476	100	118	229	24	48	117	75
Input Volume	210	435	37	6	489	107	117	247	26	47	117	77
% of Volume	97	94	103	83	97	93	101	93	92	102	100	97

1: rue St-Patrick & rue Charlevoix Performance by movement

Movement	All
Denied Delay (hr)	6.1
Denied Del/Veh (s)	11.6
Total Delay (hr)	52.6
Total Del/Veh (s)	97.7
Vehicles Entered	1878
Vehicles Exited	1842
Hourly Exit Rate	1842
Input Volume	1915
% of Volume	96

2: des Seigneurs & St-Patrick Performance by movement

Movement	EBL	EBT	EBR	WBL	WBT	WBR	NBL	NBT	NBR	SBL	SBT	SBR
Denied Delay (hr)	0.2	0.6	0.0	0.0	0.4	0.0	0.0	0.0	0.0	0.1	0.0	0.1
Denied Del/Veh (s)	7.5	4.5	0.0	0.0	2.9	0.8	0.1	0.1	0.1	0.7	0.6	3.1
Total Delay (hr)	2.7	10.3	0.1	0.1	5.6	2.2	0.0	0.0	0.0	6.5	0.1	1.4
Total Del/Veh (s)	89.1	76.5	53.1	47.5	41.9	37.4	30.3	18.5	25.7	58.7	66.3	45.0
Vehicles Entered	105	470	4	5	472	206	3	9	4	387	5	110
Vehicles Exited	105	469	4	6	475	208	3	9	4	382	5	109
Hourly Exit Rate	105	469	4	6	475	208	3	9	4	382	5	109
Input Volume	109	494	4	7	482	202	3	7	3	395	5	112
% of Volume	96	95	100	86	99	103	100	129	133	97	100	97

2: des Seigneurs & St-Patrick Performance by movement

Movement	All
Denied Delay (hr)	1.4
Denied Del/Veh (s)	2.8
Total Delay (hr)	28.9
Total Del/Veh (s)	57.2
Vehicles Entered	1780
Vehicles Exited	1779
Hourly Exit Rate	1779
Input Volume	1823
% of Volume	98

3: Shearer/Accès & St-Patrick Performance by movement

Movement	EBL	EBT	EBR	WBL	WBT	NBL	NBR	All
Denied Delay (hr)	0.0	0.1	0.0	0.0	0.6	0.0	0.3	1.0
Denied Del/Veh (s)	0.0	0.5	0.2	1.3	3.4	2.8	20.1	2.2
Total Delay (hr)	0.0	0.4	0.0	0.2	3.4	1.8	0.8	6.8
Total Del/Veh (s)	1.6	1.8	0.8	23.7	20.7	128.1	56.9	14.4
Vehicles Entered	1	873	85	36	596	50	53	1694
Vehicles Exited	1	874	85	35	591	48	51	1685
Hourly Exit Rate	1	874	85	35	591	48	51	1685
Input Volume	1	896	88	35	588	56	55	1719
% of Volume	100	98	97	100	101	86	93	98

4: St-Patrick Performance by movement

Movement	EBT	EBR	WBL	WBT	NBL	NBR	All
Denied Delay (hr)	0.0	0.0	0.0	0.0	0.0	0.0	0.0
Denied Del/Veh (s)	0.0	0.0	0.0	0.1	0.0	0.0	0.0
Total Delay (hr)	1.5	0.1	0.0	0.5	0.4	0.3	2.9
Total Del/Veh (s)	6.9	9.2	7.3	3.0	43.4	41.8	7.0
Vehicles Entered	795	26	24	560	36	28	1469
Vehicles Exited	797	26	24	559	34	26	1466
Hourly Exit Rate	797	26	24	559	34	26	1466
Input Volume	814	26	25	557	32	24	1478
% of Volume	98	100	96	100	106	108	99

5: Montmorency & St-Patrick Performance by movement

Movement	EBT	EBR	WBL	WBT	WBR	NBL	NBR	SBL	SBR	All
Denied Delay (hr)	1.6	0.0	0.0	0.0	0.0	0.4	0.3	0.0	0.0	2.3
Denied Del/Veh (s)	9.6	0.0	0.0	0.4	0.0	4.4	4.8	0.1	0.1	5.2
Total Delay (hr)	3.9	0.8	1.2	3.3	0.0	2.2	2.2	0.1	0.0	13.7
Total Del/Veh (s)	22.8	24.3	55.9	41.3	55.5	25.4	37.1	49.6	22.4	30.2
Vehicles Entered	614	124	78	281	2	306	208	6	4	1623
Vehicles Exited	609	123	76	279	2	307	208	6	4	1614
Hourly Exit Rate	609	123	76	279	2	307	208	6	4	1614
Input Volume	644	122	80	277	3	300	216	8	4	1654
% of Volume	95	101	95	101	67	102	96	75	100	98

6: Rue Bridge & Rue Saint-Patrick Performance by movement

Movement	EBT	EBR	WBL	WBT	NBL	NBT	NBR	All
Denied Delay (hr)	6.3	12.2	0.0	0.0	0.0	0.0	0.0	18.5
Denied Del/Veh (s)	55.4	71.4	0.0	0.0	0.1	0.0	0.0	44.9
Total Delay (hr)	2.8	12.0	0.0	0.5	1.3	0.0	0.0	16.6
Total Del/Veh (s)	25.3	72.0	20.8	8.3	19.2	3.5	11.2	40.8
Vehicles Entered	399	593	3	212	236	6	3	1452
Vehicles Exited	397	580	3	212	235	6	3	1436
Hourly Exit Rate	397	580	3	212	235	6	3	1436
Input Volume	437	634	4	210	233	6	2	1526
% of Volume	91	91	75	101	101	100	150	94

7: Rue Wellington & Rue Saint-Patrick Performance by movement

Movement	EBL	EBT	EBR	NBL	NBT	SBT	SBR	All
Denied Delay (hr)	0.0	0.0	0.0	0.0	0.0	0.1	0.1	0.2
Denied Del/Veh (s)	0.0	0.0	0.0	0.0	0.0	0.3	2.3	0.4
Total Delay (hr)	3.7	0.0	0.3	0.0	0.6	3.8	1.1	9.6
Total Del/Veh (s)	49.7	1.0	42.2	30.6	7.8	14.7	18.2	19.3
Vehicles Entered	265	47	26	2	295	924	214	1773
Vehicles Exited	262	47	27	2	292	924	213	1767
Hourly Exit Rate	262	47	27	2	292	924	213	1767
Input Volume	289	57	29	4	332	928	210	1849
% of Volume	91	82	93	50	88	100	101	96

8: rue Charlevoix & Rue Centre Performance by movement

Movement	EBL	EBT	EBR	WBL	WBT	WBR	NBL	NBT	NBR	SBL	SBT	SBR
Denied Delay (hr)	0.0	0.0	0.0	0.0	0.0	0.0	0.0	0.0	0.0	0.0	0.0	0.0
Denied Del/Veh (s)	0.3	0.4	0.3	0.0	0.0	0.0	0.3	0.3	0.2	0.0	0.0	0.0
Total Delay (hr)	1.4	3.0	0.6	0.2	0.3	0.4	0.3	6.0	0.1	0.1	0.4	0.0
Total Del/Veh (s)	53.9	48.9	53.9	32.0	20.1	30.5	117.2	89.4	53.3	21.7	10.0	30.3
Vehicles Entered	91	218	39	20	59	43	9	238	9	16	142	2
Vehicles Exited	89	212	37	20	59	42	9	234	9	16	142	2
Hourly Exit Rate	89	212	37	20	59	42	9	234	9	16	142	2
Input Volume	87	221	35	20	63	44	8	237	11	15	142	3
% of Volume	102	96	106	100	94	95	112	99	82	107	100	67

8: rue Charlevoix & Rue Centre Performance by movement

Movement	All
Denied Delay (hr)	0.1
Denied Del/Veh (s)	0.2
Total Delay (hr)	12.9
Total Del/Veh (s)	51.5
Vehicles Entered	886
Vehicles Exited	871
Hourly Exit Rate	871
Input Volume	886
% of Volume	98



9: rue Sucrierie Performance by movement

Movement	EBL	EBT	EBR	NBL	SBR	All
Denied Delay (hr)	0.0	0.0	0.0	0.0	0.0	0.0
Denied Del/Veh (s)	0.0	0.0	0.0	0.0	0.0	0.0
Total Delay (hr)	0.1	0.0	0.0	0.0	0.0	0.1
Total Del/Veh (s)	4.6	1.2	3.1	2.6	0.3	2.6
Vehicles Entered	63	1	10	29	59	162
Vehicles Exited	63	1	10	29	58	161
Hourly Exit Rate	63	1	10	29	58	161
Input Volume	56	1	8	33	61	159
% of Volume	112	100	125	88	95	101

10: Montmorency Performance by movement

Movement	EBL	NBT	SBT	SBR	All
Denied Delay (hr)	7.5	0.0	0.0	0.0	7.5
Denied Del/Veh (s)	153.1	0.0	0.0	0.0	39.9
Total Delay (hr)	3.9	1.5	0.0	0.0	5.4
Total Del/Veh (s)	84.9	19.0	0.5	0.4	29.1
Vehicles Entered	162	284	178	40	664
Vehicles Exited	161	283	177	40	661
Hourly Exit Rate	161	283	177	40	661
Input Volume	165	280	181	38	664
% of Volume	98	101	98	105	100

11: Montmorency Performance by movement

Movement	EBL	EBR	NBL	NBT	SBT	SBR	All
Denied Delay (hr)	0.0	0.0	0.0	0.0	0.0	0.0	0.1
Denied Del/Veh (s)	0.7	0.4	0.0	0.0	0.0	0.0	0.4
Total Delay (hr)	0.5	0.1	0.0	0.0	0.0	0.0	0.6
Total Del/Veh (s)	6.2	4.0	3.1	1.6	0.6	0.3	3.8
Vehicles Entered	270	79	57	15	84	94	599
Vehicles Exited	269	79	57	15	84	94	598
Hourly Exit Rate	269	79	57	15	84	94	598
Input Volume	268	84	57	12	87	94	602
% of Volume	100	94	100	125	97	100	99

12: Shearer & Centre Performance by movement

Movement	EBL	EBT	EBR	WBL	WBT	WBR	NBL	NBT	NBR	SBL	SBT	SBR
Denied Delay (hr)	0.0	0.0	0.0	0.0	0.0	0.0	0.0	0.0	0.0	0.0	0.0	0.0
Denied Del/Veh (s)	0.0	0.0	0.0	0.0	0.0	0.0	0.2	0.1	0.1	0.3	0.2	0.1
Total Delay (hr)	0.0	0.2	0.0	0.0	0.1	0.0	0.0	0.1	0.0	0.3	0.3	0.1
Total Del/Veh (s)	5.8	4.5	5.9	12.3	7.3	10.7	17.9	9.9	14.3	16.1	14.3	15.0
Vehicles Entered	11	179	21	6	71	4	8	30	7	66	81	14
Vehicles Exited	11	179	21	6	71	4	8	30	7	67	82	14
Hourly Exit Rate	11	179	21	6	71	4	8	30	7	67	82	14
Input Volume	12	189	19	8	74	5	10	30	7	74	86	18
% of Volume	92	95	111	75	96	80	80	100	100	91	95	78

12: Shearer & Centre Performance by movement

Movement	All
Denied Delay (hr)	0.0
Denied Del/Veh (s)	0.1
Total Delay (hr)	1.3
Total Del/Veh (s)	9.3
Vehicles Entered	498
Vehicles Exited	500
Hourly Exit Rate	500
Input Volume	532
% of Volume	94

13: rue Sucrierie & Centre Performance by movement

Movement	EBL	EBT	EBR	WBL	WBT	WBR	NBL	NBT	NBR	SBL	SBT	SBR
Denied Delay (hr)	0.0	0.0	0.0	0.0	0.0	0.0	0.0	0.0	0.0	0.0	0.0	0.0
Denied Del/Veh (s)	0.0	0.0	0.0	0.0	0.0	0.0	0.1	0.1	0.1	0.1	0.2	0.1
Total Delay (hr)	0.0	0.7	0.1	0.0	0.1	0.0	0.0	0.0	0.1	0.3	0.0	0.1
Total Del/Veh (s)	14.4	15.0	20.6	15.5	3.8	9.2	11.2	11.7	14.9	16.0	12.2	12.3
Vehicles Entered	11	169	17	6	74	8	6	8	28	59	13	27
Vehicles Exited	11	168	17	6	74	8	6	8	28	58	13	27
Hourly Exit Rate	11	168	17	6	74	8	6	8	28	58	13	27
Input Volume	15	178	18	8	77	9	7	9	26	56	13	33
% of Volume	73	94	94	75	96	89	86	89	108	104	100	82

13: rue Sucrierie & Centre Performance by movement

Movement	All
Denied Delay (hr)	0.0
Denied Del/Veh (s)	0.1
Total Delay (hr)	1.5
Total Del/Veh (s)	13.0
Vehicles Entered	426
Vehicles Exited	424
Hourly Exit Rate	424
Input Volume	449
% of Volume	94

14: rue Centre/Centre Performance by movement

Movement	EBL	EBT	WBT	WBR	SBL	SBR	All
Denied Delay (hr)	0.0	0.0	0.0	0.0	0.2	0.0	0.2
Denied Del/Veh (s)	0.0	0.0	0.1	0.1	10.7	25.6	1.7
Total Delay (hr)	0.1	0.6	0.0	0.0	0.8	0.0	1.6
Total Del/Veh (s)	19.1	9.4	0.6	0.4	45.7	20.7	12.0
Vehicles Entered	17	237	81	69	64	5	473
Vehicles Exited	17	237	81	69	63	5	472
Hourly Exit Rate	17	237	81	69	63	5	472
Input Volume	17	243	90	67	65	4	486
% of Volume	100	98	90	103	97	125	97

15: Rue Wellington & rue Centre/Accès Performance by movement

Movement	EBL	EBR	WBT	WBR	NBL	NBT	NBR	SBT	SBR	All
Denied Delay (hr)	11.3	0.0	0.0	0.0	0.0	0.0	0.0	0.0	0.0	11.3
Denied Del/Veh (s)	146.0	0.0	0.1	0.1	0.0	0.0	0.0	0.1	0.1	47.9
Total Delay (hr)	9.7	0.1	0.0	0.3	0.0	4.2	0.0	0.3	0.1	14.6
Total Del/Veh (s)	136.9	272.8	113.7	248.4	35.7	42.4	23.8	7.0	5.5	63.7
Vehicles Entered	248	1	1	4	3	353	2	132	76	820
Vehicles Exited	236	1	0	3	3	343	2	131	76	795
Hourly Exit Rate	236	1	0	3	3	343	2	131	76	795
Input Volume	283	1	1	3	3	363	2	131	79	866
% of Volume	83	100	0	100	100	94	100	100	96	92

16: Shearer & Richardson Performance by movement

Movement	WBL	WBT	WBR	NBT	SBT	All
Denied Delay (hr)	0.0	0.0	0.0	0.0	0.0	0.0
Denied Del/Veh (s)	0.0	0.0	0.0	0.0	0.0	0.0
Total Delay (hr)	0.0	0.0	0.0	0.0	0.0	0.1
Total Del/Veh (s)	5.2	1.3	4.6	0.8	0.5	1.4
Vehicles Entered	6	22	33	46	120	227
Vehicles Exited	6	22	33	46	121	228
Hourly Exit Rate	6	22	33	46	121	228
Input Volume	7	26	33	47	123	236
% of Volume	86	85	100	98	98	97

17: rue Sucrierie & Richardson Performance by movement

Movement	WBL	WBT	WBR	NBL	NBT	SBT	SBR	All
Denied Delay (hr)	0.0	0.0	0.0	0.0	0.0	0.0	0.0	0.0
Denied Del/Veh (s)	0.1	0.0	0.0	0.0	0.0	0.0	0.0	0.0
Total Delay (hr)	0.0	0.1	0.0	0.0	0.0	0.0	0.0	0.2
Total Del/Veh (s)	4.4	5.1	4.0	4.4	4.7	3.1	2.3	4.6
Vehicles Entered	30	45	5	16	17	9	1	123
Vehicles Exited	30	45	5	15	18	9	1	123
Hourly Exit Rate	30	45	5	15	18	9	1	123
Input Volume	32	46	5	19	21	7	1	131
% of Volume	94	98	100	79	86	129	100	94

18: Richardson & Montmorency Performance by movement

Movement	WBL	WBT	WBR	NBL	NBT	SBT	SBR	All
Denied Delay (hr)	0.0	0.0	0.0	0.0	0.0	0.0	0.0	0.0
Denied Del/Veh (s)	0.2	0.1	0.1	0.0	0.0	0.0	0.0	0.0
Total Delay (hr)	0.0	0.0	0.0	0.0	0.1	0.1	0.0	0.2
Total Del/Veh (s)	5.1	4.5	2.4	4.0	3.8	1.9	2.6	2.8
Vehicles Entered	2	18	2	16	70	138	16	262
Vehicles Exited	2	18	2	17	70	138	16	263
Hourly Exit Rate	2	18	2	17	70	138	16	263
Input Volume	2	18	1	16	68	140	21	266
% of Volume	100	100	200	106	103	99	76	99

19: rue de la Prairie & Rue Centre Performance by movement

Movement	EBT	WBT	All
Denied Delay (hr)	0.0	0.0	0.0
Denied Del/Veh (s)	0.0	0.1	0.0
Total Delay (hr)	0.4	0.2	0.7
Total Del/Veh (s)	6.8	6.4	6.7
Vehicles Entered	234	123	357
Vehicles Exited	234	123	357
Hourly Exit Rate	234	123	357
Input Volume	244	127	371
% of Volume	96	97	96

20: Rue Bridge & Rue Wellington Performance by movement

Movement	EBT	EBR	WBL	WBT	NBL	NBT	NBR	SBT	SBR	All
Denied Delay (hr)	0.8	1.7	0.0	0.0	0.0	0.0	0.0	0.1	0.0	2.5
Denied Del/Veh (s)	12.1	16.2	0.0	0.1	0.2	0.1	0.1	0.4	0.0	3.7
Total Delay (hr)	7.4	20.4	8.1	1.0	0.4	5.7	0.4	29.3	0.1	72.9
Total Del/Veh (s)	112.1	188.2	39.0	16.1	95.0	89.5	16.2	173.7	262.5	102.5
Vehicles Entered	231	372	752	233	15	215	90	585	2	2495
Vehicles Exited	226	361	739	232	15	219	91	576	2	2461
Hourly Exit Rate	226	361	739	232	15	219	91	576	2	2461
Input Volume	263	409	761	232	15	214	97	639	3	2633
% of Volume	86	88	97	100	100	102	94	90	67	93

21: Rue Ropery & Rue Centre Performance by movement

Movement	EBT	WBT	All
Denied Delay (hr)	0.0	0.0	0.0
Denied Del/Veh (s)	0.0	0.0	0.0
Total Delay (hr)	0.6	0.6	1.2
Total Del/Veh (s)	9.1	17.5	12.0
Vehicles Entered	238	123	361
Vehicles Exited	238	122	360
Hourly Exit Rate	238	122	360
Input Volume	248	127	375
% of Volume	96	96	96

23: Rue Island & Rue Centre Performance by movement

Movement	EBL	EBT	WBT	WBR	NBL	NBT	NBR	All
Denied Delay (hr)	0.0	0.0	0.0	0.0	0.0	0.0	0.0	0.0
Denied Del/Veh (s)	0.0	0.0	0.0	0.0	0.1	0.1	0.2	0.0
Total Delay (hr)	0.1	1.0	0.4	0.0	0.0	0.1	0.1	1.7
Total Del/Veh (s)	20.1	17.4	14.6	12.7	17.7	10.8	12.1	16.0
Vehicles Entered	13	207	96	11	6	24	21	378
Vehicles Exited	13	206	97	11	6	24	21	378
Hourly Exit Rate	13	206	97	11	6	24	21	378
Input Volume	13	220	100	12	5	24	20	394
% of Volume	100	94	97	92	120	100	105	96

40: Performance by movement

Movement	NBT	All
Denied Delay (hr)	0.0	0.0
Denied Del/Veh (s)	0.0	0.0
Total Delay (hr)	0.0	0.0
Total Del/Veh (s)	0.8	0.8
Vehicles Entered	47	47
Vehicles Exited	47	47
Hourly Exit Rate	47	47
Input Volume	49	49
% of Volume	96	96

45: St-Patrick/Rue Saint-Patrick Performance by movement

Movement	EBL	EBT	WBT	WBR	NBL	NBR	SBL	SBR	All
Denied Delay (hr)	0.0	0.2	0.0	0.0	0.0	0.0	0.0	0.0	0.3
Denied Del/Veh (s)	0.0	1.6	0.0	0.0	0.2	3.9	0.1	0.1	0.8
Total Delay (hr)	0.0	3.3	2.3	0.0	0.1	0.1	0.0	0.0	5.8
Total Del/Veh (s)	20.1	22.7	15.1	14.7	5.6	7.5	5.9	3.1	18.0
Vehicles Entered	3	522	549	2	35	33	4	3	1151
Vehicles Exited	3	524	542	2	35	33	4	3	1146
Hourly Exit Rate	3	524	542	2	35	33	4	3	1146
Input Volume	5	551	561	2	38	31	5	3	1196
% of Volume	60	95	97	100	92	106	80	100	96

48: Performance by movement

Movement	EBT	WBL	WBT	NBR	All
Denied Delay (hr)	0.0	0.0	0.0	0.0	0.0
Denied Del/Veh (s)	0.2	0.0	0.0	0.1	0.1
Total Delay (hr)	0.1	0.1	0.1	0.0	0.3
Total Del/Veh (s)	8.7	7.5	7.3	4.7	7.6
Vehicles Entered	56	42	48	18	164
Vehicles Exited	56	42	48	18	164
Hourly Exit Rate	56	42	48	18	164
Input Volume	49	44	52	16	161
% of Volume	114	95	92	112	102

---

Total Network Performance

---

Denied Delay (hr)	51.7
Denied Del/Veh (s)	30.2
Total Delay (hr)	258.4
Total Del/Veh (s)	145.6
Vehicles Entered	6046
Vehicles Exited	5867
Hourly Exit Rate	5867
Input Volume	28559
% of Volume	21

**Intersection: 1: rue St-Patrick & rue Charlevoix**

Movement	EB	EB	WB	WB	NB	NB	SB	SB
Directions Served	LT	R	LT	R	LT	R	LT	R
Maximum Queue (m)	500.2	37.5	85.2	37.5	204.8	14.5	77.0	18.2
Average Queue (m)	297.9	16.9	39.1	15.8	156.0	6.6	37.8	12.5
95th Queue (m)	566.8	45.6	71.7	39.2	259.2	16.5	64.4	19.5
Link Distance (m)	698.5		365.4		213.9		893.1	
Upstream Blk Time (%)	1				17			
Queuing Penalty (veh)	0				61			
Storage Bay Dist (m)		30.0		30.0		7.0		7.0
Storage Blk Time (%)	65	0	12	0	77	8	58	29
Queuing Penalty (veh)	24	1	13	1	20	28	45	48

**Intersection: 2: des Seigneurs & St-Patrick**

Movement	EB	EB	WB	WB	NB	SB	SB
Directions Served	LT	TR	LT	R	LTR	LT	R
Maximum Queue (m)	163.7	67.5	68.2	64.0	14.2	188.4	17.5
Average Queue (m)	127.9	56.7	63.4	34.2	3.1	98.7	13.5
95th Queue (m)	192.9	93.2	74.1	58.7	10.8	185.3	23.1
Link Distance (m)	159.4		57.6	57.6	57.0	294.2	
Upstream Blk Time (%)	10		37	3			
Queuing Penalty (veh)	58		119	9			
Storage Bay Dist (m)		60.0					10.0
Storage Blk Time (%)	57	4				60	2
Queuing Penalty (veh)	142	14				67	6

**Intersection: 3: Shearer/Accès & St-Patrick**

Movement	EB	EB	WB	NB	NB
Directions Served	LT	R	LTR	LT	R
Maximum Queue (m)	51.4	14.0	138.8	82.5	22.5
Average Queue (m)	5.5	0.7	59.9	26.6	11.6
95th Queue (m)	29.8	5.6	132.1	74.0	26.0
Link Distance (m)	57.6	57.6	141.4	164.9	
Upstream Blk Time (%)	1		2		
Queuing Penalty (veh)	4		10		
Storage Bay Dist (m)					15.0
Storage Blk Time (%)				38	2
Queuing Penalty (veh)				21	1



**Intersection: 4: St-Patrick**

Movement	EB	WB	NB
Directions Served	TR	LT	LR
Maximum Queue (m)	100.5	70.4	45.8
Average Queue (m)	24.3	10.0	13.3
95th Queue (m)	94.1	40.1	31.3
Link Distance (m)	141.4	93.5	72.9
Upstream Blk Time (%)	1		0
Queuing Penalty (veh)	8		0
Storage Bay Dist (m)			
Storage Blk Time (%)			
Queuing Penalty (veh)			

**Intersection: 5: Montmorency & St-Patrick**

Movement	EB	EB	WB	NB	NB	SB
Directions Served	T	R	LTR	LT	R	LTR
Maximum Queue (m)	98.1	22.5	134.7	29.5	28.8	12.5
Average Queue (m)	78.0	13.3	60.2	26.7	25.5	2.5
95th Queue (m)	111.0	28.4	127.1	32.0	31.8	8.7
Link Distance (m)	93.5		196.1	25.4	25.4	55.0
Upstream Blk Time (%)	10		0	36	34	
Queuing Penalty (veh)	67		0	81	75	
Storage Bay Dist (m)		15.0				
Storage Blk Time (%)	41	7	56			10
Queuing Penalty (veh)	50	43	1			0

**Intersection: 6: Rue Bridge & Rue Saint-Patrick**

Movement	EB	EB	WB	WB	NB	NB
Directions Served	LT	R	L	T	L	TR
Maximum Queue (m)	181.1	191.8	2.3	23.9	71.3	9.0
Average Queue (m)	70.4	124.0	0.2	8.1	24.5	0.5
95th Queue (m)	163.5	231.6	1.3	20.2	58.4	3.9
Link Distance (m)	196.1	196.1	225.7	225.7	148.6	148.6
Upstream Blk Time (%)	1	7				
Queuing Penalty (veh)	6	31				
Storage Bay Dist (m)						
Storage Blk Time (%)						
Queuing Penalty (veh)						

**Intersection: 7: Rue Wellington & Rue Saint-Patrick**

Movement	EB	EB	NB	NB	SB	SB	SB
Directions Served	L	R	LT	T	T	T	R
Maximum Queue (m)	78.7	19.4	36.1	43.1	85.0	91.3	9.3
Average Queue (m)	45.7	6.0	9.6	11.6	51.2	56.2	8.9
95th Queue (m)	71.4	15.3	27.4	31.5	74.4	82.8	9.5
Link Distance (m)	225.7	225.7	167.6	167.6	260.1	260.1	
Upstream Blk Time (%)							
Queuing Penalty (veh)							
Storage Bay Dist (m)							0.1
Storage Blk Time (%)						24	19
Queuing Penalty (veh)						50	86

**Intersection: 8: rue Charlevoix & Rue Centre**

Movement	EB	WB	NB	SB
Directions Served	LTR	LTR	LTR	LTR
Maximum Queue (m)	138.6	54.3	136.8	39.8
Average Queue (m)	62.7	22.7	68.4	15.4
95th Queue (m)	140.5	43.0	177.4	30.9
Link Distance (m)	664.8	218.4	403.6	213.9
Upstream Blk Time (%)				
Queuing Penalty (veh)				
Storage Bay Dist (m)				
Storage Blk Time (%)	58	37		
Queuing Penalty (veh)	10	8		

**Intersection: 9: rue Sucrierie**

Movement	EB	NB
Directions Served	LR	LT
Maximum Queue (m)	18.1	8.5
Average Queue (m)	9.2	0.6
95th Queue (m)	15.8	4.3
Link Distance (m)	29.7	82.6
Upstream Blk Time (%)	0	
Queuing Penalty (veh)	0	
Storage Bay Dist (m)		
Storage Blk Time (%)		
Queuing Penalty (veh)		

Intersection: 10: Montmorency

Movement	EB	NB	SB
Directions Served	LR	LT	T
Maximum Queue (m)	40.5	66.7	6.6
Average Queue (m)	33.0	29.5	0.2
95th Queue (m)	51.5	59.9	2.1
Link Distance (m)	35.9	80.8	25.4
Upstream Blk Time (%)	57	1	
Queuing Penalty (veh)	0	2	
Storage Bay Dist (m)			
Storage Blk Time (%)			
Queuing Penalty (veh)			

Intersection: 11: Montmorency

Movement	EB	NB	SB
Directions Served	LR	LT	TR
Maximum Queue (m)	31.6	12.0	1.4
Average Queue (m)	22.3	3.3	0.0
95th Queue (m)	33.1	10.9	1.0
Link Distance (m)	27.0	35.8	80.8
Upstream Blk Time (%)	4		
Queuing Penalty (veh)	0		
Storage Bay Dist (m)			
Storage Blk Time (%)			
Queuing Penalty (veh)			

Intersection: 12: Shearer & Centre

Movement	EB	EB	WB	WB	NB	SB
Directions Served	LT	R	LT	R	LTR	LTR
Maximum Queue (m)	22.9	9.2	27.4	9.6	19.3	43.4
Average Queue (m)	5.1	0.8	7.6	0.7	6.0	19.1
95th Queue (m)	15.3	4.9	19.3	4.9	14.5	34.9
Link Distance (m)	231.8		136.3		152.8	73.8
Upstream Blk Time (%)						
Queuing Penalty (veh)						
Storage Bay Dist (m)		15.0		15.0		
Storage Blk Time (%)	2	0	4		12	35
Queuing Penalty (veh)	0	0	0		0	3

**Intersection: 13: rue Sucrierie & Centre**

Movement	EB	WB	WB	NB	SB
Directions Served	LTR	LT	R	LTR	LTR
Maximum Queue (m)	48.4	20.0	7.3	16.0	26.7
Average Queue (m)	20.8	5.0	1.1	5.4	12.0
95th Queue (m)	39.2	14.1	5.2	13.7	24.0
Link Distance (m)	136.3	99.5		156.3	73.1
Upstream Blk Time (%)					
Queuing Penalty (veh)					
Storage Bay Dist (m)			15.0		
Storage Blk Time (%)	32	1		13	24
Queuing Penalty (veh)	3	0		2	4

**Intersection: 14: rue Centre/Centre**

Movement	EB	SB
Directions Served	LT	LR
Maximum Queue (m)	36.2	29.9
Average Queue (m)	7.3	13.8
95th Queue (m)	38.0	37.8
Link Distance (m)	99.5	72.5
Upstream Blk Time (%)	1	1
Queuing Penalty (veh)	3	0
Storage Bay Dist (m)		
Storage Blk Time (%)		
Queuing Penalty (veh)		

**Intersection: 15: Rue Wellington & rue Centre/Accès**

Movement	EB	WB	NB	NB	B37	SB	SB
Directions Served	LTR	LTR	LT	TR	T	LT	TR
Maximum Queue (m)	144.1	36.5	77.2	74.4	63.3	42.5	29.5
Average Queue (m)	90.4	6.1	31.7	31.1	4.1	11.8	7.5
95th Queue (m)	176.4	26.4	75.3	68.8	40.4	27.8	21.0
Link Distance (m)	167.7	202.8	78.0	78.0	296.5	178.0	178.0
Upstream Blk Time (%)	12		5	2			
Queuing Penalty (veh)	21		0	0			
Storage Bay Dist (m)							
Storage Blk Time (%)							
Queuing Penalty (veh)							

Intersection: 16: Shearer & Richardson

Movement	WB	SB
Directions Served	LTR	TR
Maximum Queue (m)	14.6	1.8
Average Queue (m)	7.0	0.1
95th Queue (m)	14.1	1.4
Link Distance (m)	145.7	164.9
Upstream Blk Time (%)		
Queuing Penalty (veh)		
Storage Bay Dist (m)		
Storage Blk Time (%)		
Queuing Penalty (veh)		

Intersection: 17: rue Sucrierie & Richardson

Movement	WB	NB	SB
Directions Served	LTR	LT	TR
Maximum Queue (m)	15.2	11.7	9.2
Average Queue (m)	9.1	6.4	1.8
95th Queue (m)	12.8	13.3	7.7
Link Distance (m)	96.0	73.1	82.6
Upstream Blk Time (%)			
Queuing Penalty (veh)			
Storage Bay Dist (m)			
Storage Blk Time (%)			
Queuing Penalty (veh)			

Intersection: 18: Richardson & Montmorency

Movement	WB	NB	SB
Directions Served	LTR	LT	TR
Maximum Queue (m)	12.1	13.6	13.3
Average Queue (m)	5.2	8.5	8.4
95th Queue (m)	13.0	12.9	13.2
Link Distance (m)	197.6	72.5	35.8
Upstream Blk Time (%)			
Queuing Penalty (veh)			
Storage Bay Dist (m)			
Storage Blk Time (%)			
Queuing Penalty (veh)			

**Intersection: 19: rue de la Prairie & Rue Centre**

Movement	EB	WB
Directions Served	LTR	LTR
Maximum Queue (m)	32.3	22.8
Average Queue (m)	13.7	9.2
95th Queue (m)	28.0	19.2
Link Distance (m)	127.7	127.0
Upstream Blk Time (%)		
Queuing Penalty (veh)		
Storage Bay Dist (m)		
Storage Blk Time (%)		
Queuing Penalty (veh)		

**Intersection: 20: Rue Bridge & Rue Wellington**

Movement	EB	EB	WB	WB	WB	NB	NB	NB	SB	SB
Directions Served	T	R	L	LT	TR	LT	TR	R	LT	TR
Maximum Queue (m)	185.5	186.7	126.8	128.7	84.0	88.7	89.6	46.1	149.1	167.2
Average Queue (m)	138.5	146.7	70.9	72.5	25.6	53.0	33.8	9.4	125.2	138.9
95th Queue (m)	221.1	223.9	114.1	116.2	70.2	87.0	77.2	32.7	185.0	205.5
Link Distance (m)	178.0	178.0	167.6	167.6		697.0	697.0		148.6	148.6
Upstream Blk Time (%)	20	31							1	32
Queuing Penalty (veh)	64	101							3	102
Storage Bay Dist (m)					70.0			60.0		
Storage Blk Time (%)				11	0		3			
Queuing Penalty (veh)				5	0		1			

**Intersection: 21: Rue Ropery & Rue Centre**

Movement	EB	WB
Directions Served	LT	LT
Maximum Queue (m)	33.7	41.5
Average Queue (m)	15.5	21.1
95th Queue (m)	29.7	36.6
Link Distance (m)	218.4	127.7
Upstream Blk Time (%)		
Queuing Penalty (veh)		
Storage Bay Dist (m)		
Storage Blk Time (%)	13	2
Queuing Penalty (veh)	0	0

**Intersection: 23: Rue Island & Rue Centre**

Movement	EB	WB	NB
Directions Served	LT	TR	LTR
Maximum Queue (m)	47.8	34.8	23.8
Average Queue (m)	24.6	14.9	7.5
95th Queue (m)	43.0	28.5	19.0
Link Distance (m)	127.0	231.8	155.4
Upstream Blk Time (%)			
Queuing Penalty (veh)			
Storage Bay Dist (m)			
Storage Blk Time (%)			13
Queuing Penalty (veh)			1

**Intersection: 40:**

Movement
Directions Served
Maximum Queue (m)
Average Queue (m)
95th Queue (m)
Link Distance (m)
Upstream Blk Time (%)
Queuing Penalty (veh)
Storage Bay Dist (m)
Storage Blk Time (%)
Queuing Penalty (veh)

**Intersection: 45: St-Patrick/Rue Saint-Patrick**

Movement	EB	B39	WB	NB	NB	SB	SB
Directions Served	LT	T	TR	LT	R	L	R
Maximum Queue (m)	116.6	14.0	68.2	13.2	14.2	9.1	9.1
Average Queue (m)	45.7	0.6	45.6	6.7	7.8	1.2	0.7
95th Queue (m)	106.4	9.4	65.0	13.7	17.3	6.3	4.7
Link Distance (m)	158.1	365.4	159.4			57.2	57.2
Upstream Blk Time (%)	2						
Queuing Penalty (veh)	8						
Storage Bay Dist (m)					10.0		
Storage Blk Time (%)				4	5		
Queuing Penalty (veh)				1	2		

Intersection: 48:

Movement	EB	WB	NB
Directions Served	T	LT	R
Maximum Queue (m)	18.8	25.5	6.7
Average Queue (m)	7.1	9.9	1.4
95th Queue (m)	16.5	21.2	5.7
Link Distance (m)	14.7	29.7	31.2
Upstream Blk Time (%)	2	0	
Queuing Penalty (veh)	0	0	
Storage Bay Dist (m)			
Storage Blk Time (%)			
Queuing Penalty (veh)			

Network Summary

Network wide Queuing Penalty: 1535



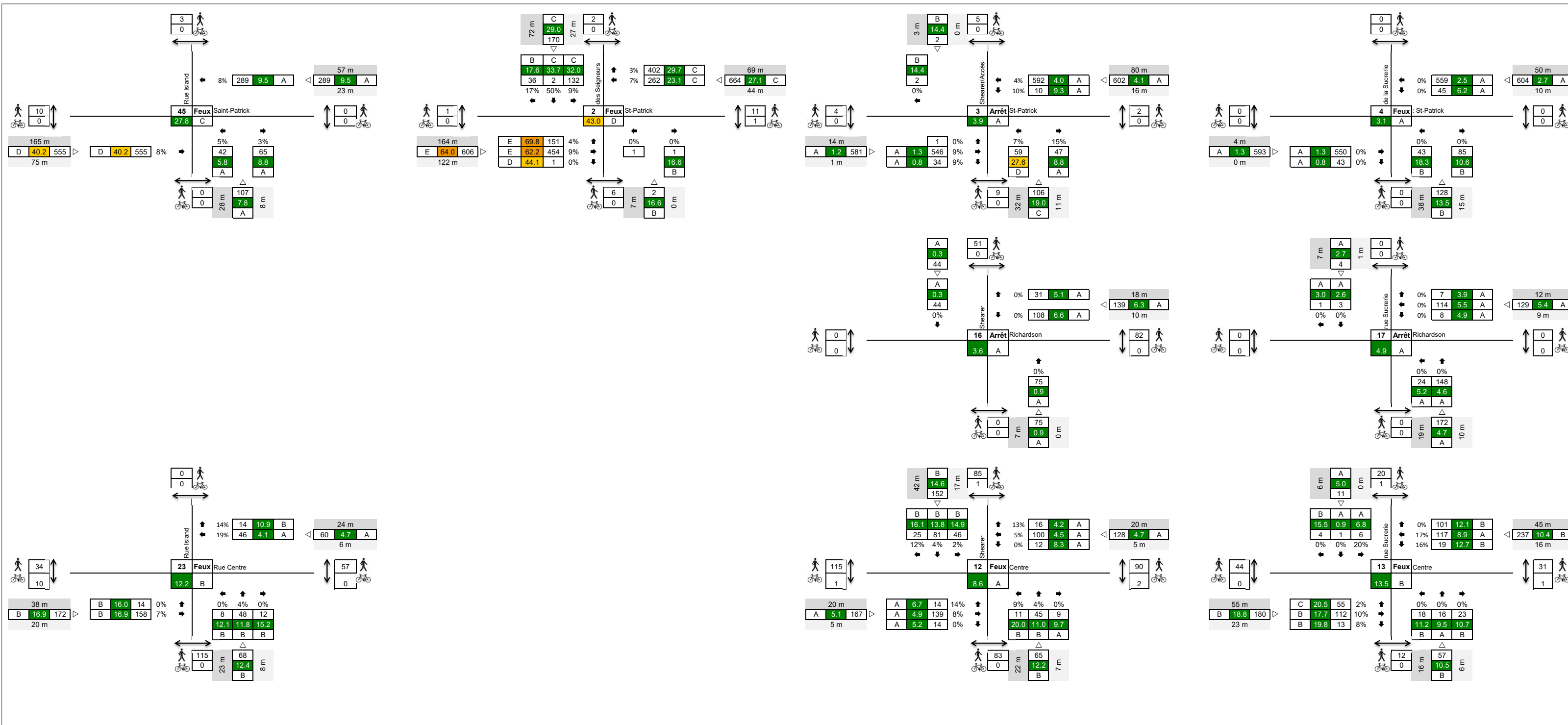

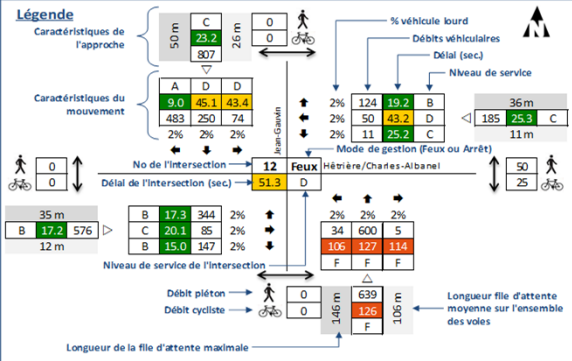
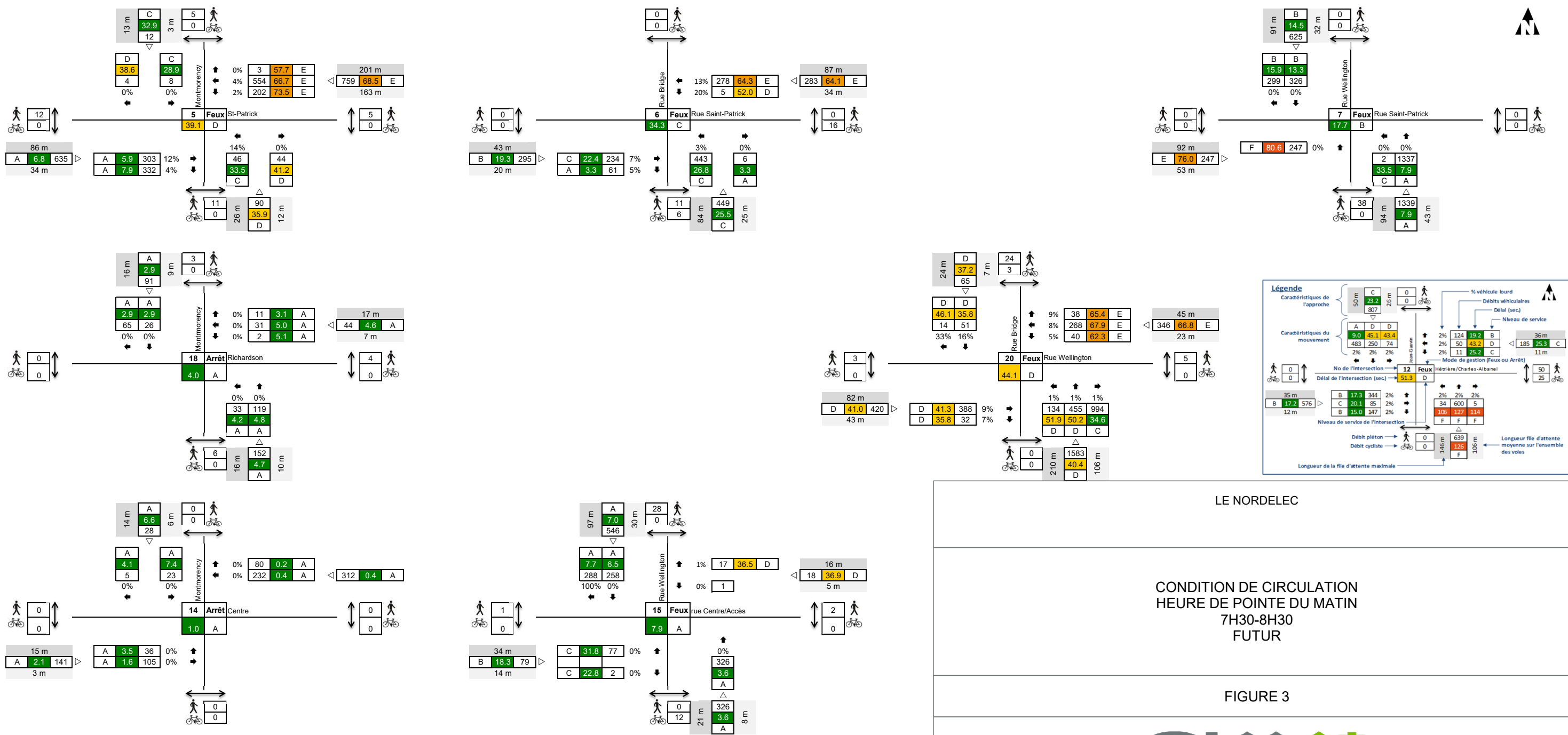

LE NORDELEC

CONDITION DE CIRCULATION  
 HEURE DE POINTE DU MATIN  
 7H30-8H30  
 FUTUR

FIGURE 3



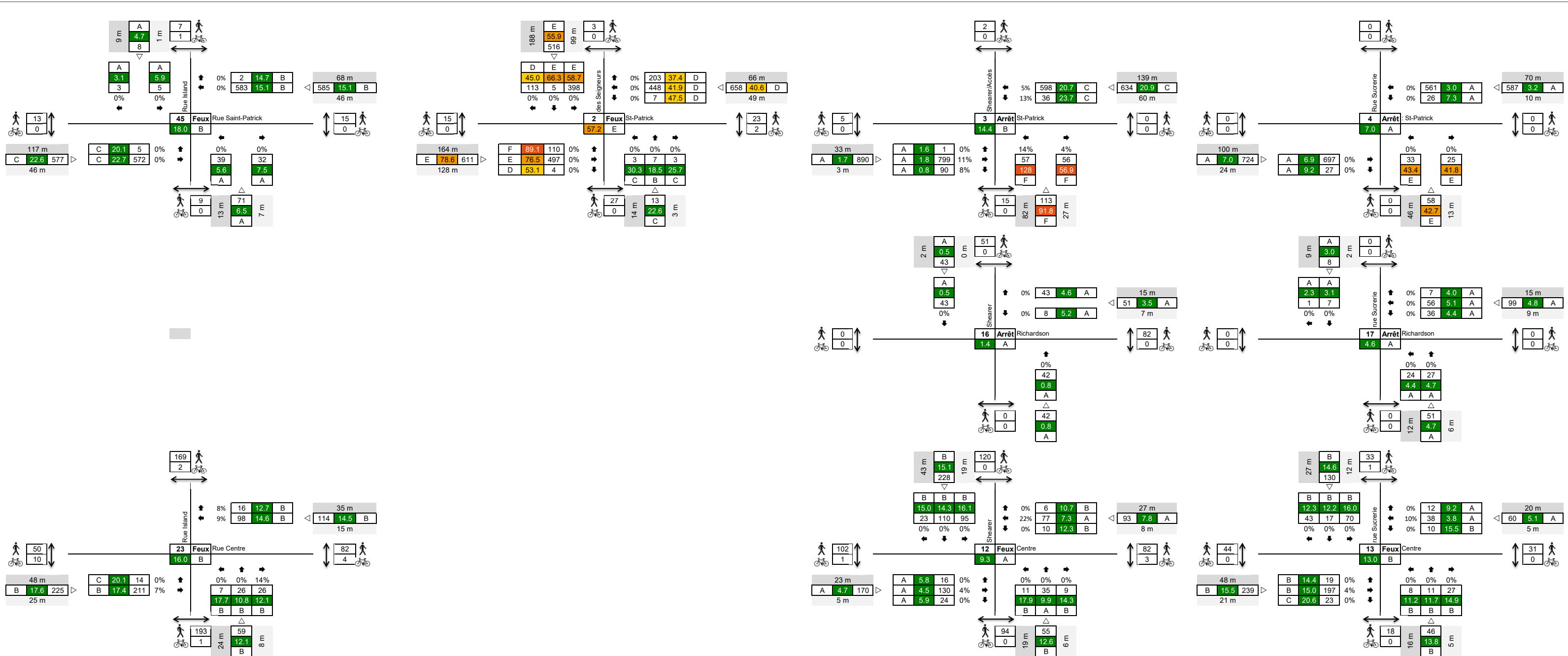

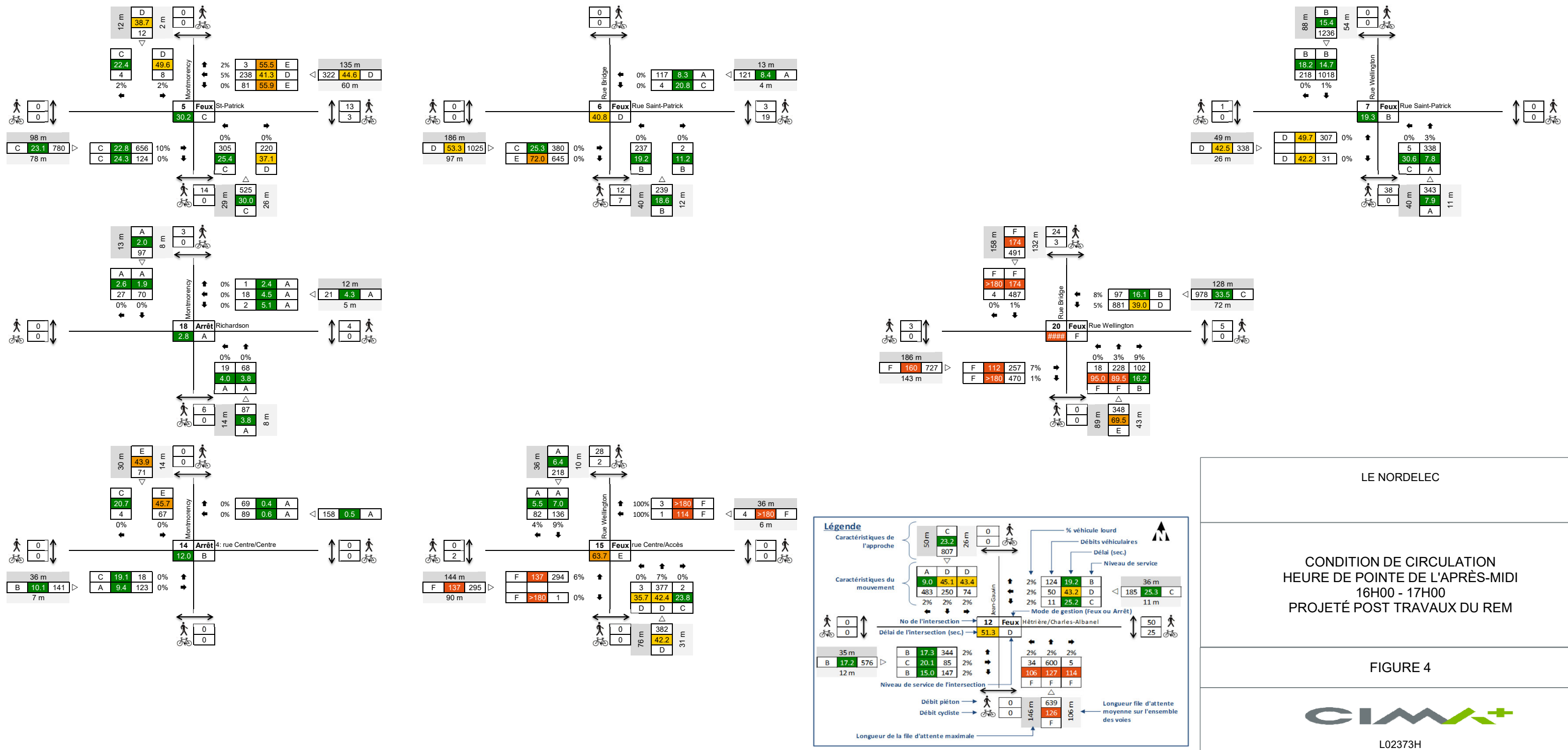

# E

## Annexe E Détail des analyses de stationnement

#de projet: L02373H  
 Titre projet: EIC Le Nordelec  
 Objet: Calcul de la demande en stationnement selon le Parking Generation Manual, 5th Edition  
 Fait par: Eric Séguin, ing., RSP (OIQ: 5058700)  
 Date: 7 novembre, 2022

Heure de la journée	Offre in situ	Demande en semaine	Demande la fin de semaine	Excédent en semaine	Excédent en fin de semaine
0 h 00	965	85	220	Aucun	Aucun
1 h 00	965	85	220	Aucun	Aucun
2 h 00	965	85	220	Aucun	Aucun
3 h 00	965	85	220	Aucun	Aucun
4 h 00	965	85	220	Aucun	Aucun
5 h 00	965	79	218	Aucun	Aucun
6 h 00	965	284	214	Aucun	Aucun
7 h 00	965	595	209	Aucun	Aucun
8 h 00	965	844	243	Aucun	Aucun
9 h 00	965	891	276	Aucun	Aucun
10 h 00	965	937	311	Aucun	Aucun
11 h 00	965	945	341	Aucun	Aucun
12 h 00	965	972	374	7	Aucun
13 h 00	965	955	359	Aucun	Aucun
14 h 00	965	928	366	Aucun	Aucun
15 h 00	965	893	361	Aucun	Aucun
16 h 00	965	619	356	Aucun	Aucun
17 h 00	965	331	310	Aucun	Aucun
18 h 00	965	261	291	Aucun	Aucun
19 h 00	965	159	273	Aucun	Aucun
20 h 00	965	137	301	Aucun	Aucun
21 h 00	965	120	250	Aucun	Aucun
22 h 00	965	98	237	Aucun	Aucun
23 h 00	965	79	194	Aucun	Aucun

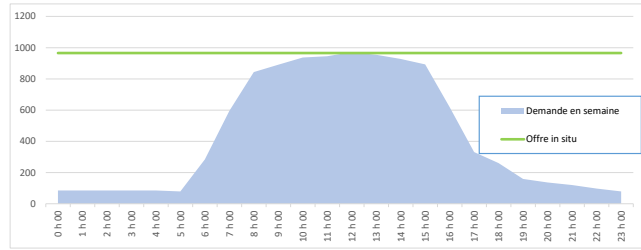

Multifamily Housing (High Rise)		
Heure de la journée	Jour semaine	Samedi
0 h 00	100%	100%
1 h 00	100%	100%
2 h 00	100%	100%
3 h 00	100%	100%
4 h 00	100%	100%
5 h 00	94%	99%
6 h 00	83%	97%
7 h 00	71%	95%
8 h 00	61%	88%
9 h 00	55%	83%
10 h 00	54%	75%
11 h 00	53%	71%
12 h 00	50%	68%
13 h 00	49%	66%
14 h 00	49%	70%
15 h 00	50%	69%
16 h 00	58%	72%
17 h 00	64%	74%
18 h 00	67%	74%
19 h 00	70%	73%
20 h 00	76%	75%
21 h 00	83%	78%
22 h 00	90%	82%
23 h 00	93%	88%

Taux ITE ParkGen  
 Dense Multi-Use Urban (rail transit <1/2 mile)  
 0.44 places / unité jour semaine  
 1.15 places / unité samedi  
 191 unités

Demande en stationnement résidentielle		
Heure de la journée	Semaine	Samedi
0 h 00	85	220
1 h 00	85	220
2 h 00	85	220
3 h 00	85	220
4 h 00	85	220
5 h 00	79	218
6 h 00	70	214
7 h 00	60	209
8 h 00	52	194
9 h 00	47	183
10 h 00	46	165
11 h 00	45	156
12 h 00	43	150
13 h 00	42	145
14 h 00	42	154
15 h 00	43	152
16 h 00	49	159
17 h 00	54	163
18 h 00	57	163
19 h 00	59	161
20 h 00	64	165
21 h 00	70	172
22 h 00	76	181
23 h 00	79	194

General Office		
Heure de la journée	Jour semaine	Samedi
0 h 00	0%	0%
1 h 00	0%	0%
2 h 00	0%	0%
3 h 00	0%	0%
4 h 00	0%	0%
5 h 00	0%	0%
6 h 00	26%	0%
7 h 00	65%	0%
8 h 00	95%	1%
9 h 00	100%	3%
10 h 00	100%	4%
11 h 00	99%	5%
12 h 00	99%	8%
13 h 00	97%	5%
14 h 00	94%	4%
15 h 00	90%	3%
16 h 00	56%	2%
17 h 00	20%	0%
18 h 00	11%	0%
19 h 00	0%	0%
20 h 00	0%	0%
21 h 00	0%	0%
22 h 00	0%	0%
23 h 00	0%	0%

Taux ITE ParkGen  
 Dense-Multi Use Urban  
 0.5582848 places / 1000pi<sup>2</sup> jour semaine  
 0.28 places / 1000pi<sup>2</sup> samedi  
 1471664 pi<sup>2</sup>

Demande en stationnement commerciale		
Heure de la journée	Semaine	Samedi
0 h 00	0	0
1 h 00	0	0
2 h 00	0	0
3 h 00	0	0
4 h 00	0	0
5 h 00	0	0
6 h 00	214	0
7 h 00	535	0
8 h 00	781	5
9 h 00	822	13
10 h 00	822	17
11 h 00	814	21
12 h 00	814	33
13 h 00	797	21
14 h 00	773	17
15 h 00	740	13
16 h 00	461	9
17 h 00	165	0
18 h 00	91	0
19 h 00	0	0
20 h 00	0	0
21 h 00	0	0
22 h 00	0	0
23 h 00	0	0

Shopping Center		
Heure de la journée	Jour semaine	Samedi
0 h 00	0%	0%
1 h 00	0%	0%
2 h 00	0%	0%
3 h 00	0%	0%
4 h 00	0%	0%
5 h 00	0%	0%
6 h 00	0%	0%
7 h 00	0%	0%
8 h 00	15%	27%
9 h 00	32%	46%
10 h 00	54%	67%
11 h 00	71%	85%
12 h 00	99%	95%

Taux ITE ParkGen  
 Dense Multi-Use Urban  
 1.2502 places / 1000pi<sup>2</sup> jour semaine  
 2.57 places / 1000pi<sup>2</sup> samedi  
 54600 pi<sup>2</sup>

Demande en stationnement commerciale		
Heure de la journée	Semaine	Samedi
0 h 00	0	0
1 h 00	0	0
2 h 00	0	0
3 h 00	0	0
4 h 00	0	0
5 h 00	0	0
6 h 00	0	0
7 h 00	0	0
8 h 00	11	38
9 h 00	22	65
10 h 00	37	95
11 h 00	49	120
12 h 00	68	134

13 h 00	100%	100%
14 h 00	90%	98%
15 h 00	83%	92%
16 h 00	81%	86%
17 h 00	84%	79%
18 h 00	86%	71%
19 h 00	80%	69%
20 h 00	63%	90%
21 h 00	42%	51%
22 h 00	15%	38%
23 h 00	0%	0%

13 h 00	69	141
14 h 00	62	138
15 h 00	57	130
16 h 00	56	121
17 h 00	58	111
18 h 00	59	100
19 h 00	55	97
20 h 00	44	127
21 h 00	29	72
22 h 00	11	54
23 h 00	0	0

Supermarket		
Heure de la journée	Jour semaine	Samedi
0 h 00	0%	0%
1 h 00	0%	0%
2 h 00	0%	0%
3 h 00	0%	0%
4 h 00	0%	0%
5 h 00	0%	0%
6 h 00	0%	0%
7 h 00	0%	0%
8 h 00	0%	8%
9 h 00	0%	22%
10 h 00	59%	50%
11 h 00	67%	65%
12 h 00	86%	85%
13 h 00	87%	77%
14 h 00	93%	85%
15 h 00	97%	99%
16 h 00	97%	100%
17 h 00	100%	53%
18 h 00	99%	42%
19 h 00	83%	22%
20 h 00	53%	13%
21 h 00	38%	9%
22 h 00	20%	3%
23 h 00	0%	0%

Taux ITE ParkGen  
Dense Multi-Use Urban  
1.9646 places / 1000pi<sup>2</sup> jour semaine  
2.43 places / 1000pi<sup>2</sup> samedi  
27400 pi<sup>2</sup>

Demande en stationnement commerciale		
Heure de la journée	Semaine	Samedi
0 h 00	0	0
1 h 00	0	0
2 h 00	0	0
3 h 00	0	0
4 h 00	0	0
5 h 00	0	0
6 h 00	0	0
7 h 00	0	0
8 h 00	0	6
9 h 00	0	15
10 h 00	32	34
11 h 00	37	44
12 h 00	47	57
13 h 00	47	52
14 h 00	51	57
15 h 00	53	66
16 h 00	53	67
17 h 00	54	36
18 h 00	54	28
19 h 00	45	15
20 h 00	29	9
21 h 00	21	6
22 h 00	11	2
23 h 00	0	0